

HOLLAND[®]
SNAP FRAME
Sign & more

Your Sign and Display supplier

2021-2022



Sign & more
www.hollandsnapframe.com

Tel +31 33 25 81 179



Here you are!
Here is the new catalog of Holland Snap Frame BV.

We have been in wholesale for the national and international market for almost 25 years in all kinds of displays, custom-made products and various presentation systems.

Ever since the very first beginning, we have continued to develop and we grew together with our customers.

In this catalog you will find only a selection of all the products we have. As a sister company of the market leader in the Netherlands www.isca.nl we also produce various light-boxes and advertisements for sign-makers etc.

Our goal is to create long-term partnership with our customers.

Quality and service are a first priority to us.

Our staff is trained regularly so that quality can be guaranteed.

We have a large warehouse where most products are on stock so that we can deliver you in a timely manner.

We believe you will be able to provide insight into the many possibilities we can offer you with this catalog.

On our website you will find more products and we invite you to come up with new and innovative ideas.

Register on www.hollandsnapframe.com or call us!
We are waiting for you.

Once a customer, always a customer!
We look forward to a successful partnership!

Paul Bakker
+31(0)33-25 81 179



INDEX

OPTI FRAMES

06

SNAP FRAMES

08

SLIDE-IN-FRAMES

16

POSTER SYSTEMS

17

SIGNAGE

19

MENUBOARDS

24

PAVEMENT SIGNS

27

WOOD DISPLAY

35

ILLUMINATED PRODUCTS

36

SHOWBOARDS

42

INDEX

44

NOTICEBOARDS

45

TEXTILE FRAMES

47

ROLL BANNERS AND QUICK BANNERS

51

BROCHURE SYSTEMS

56

IPAD STANDS

57

EXHIBITION SYSTEMS

58

COUNTER DISPLAYS

59

LEAFLET DISPENSERS

62

TUBES, CLAMPS AND TENSIONERS

68

OTHER PRODUCTS

Opti Frame, a contemporary poster display system, is an innovative and patented snap frame. It provides multifunction in one produce. You can use the same unit on the wall or a counter in landscape or portrait positions. It can be used for signage needs of many locations; hotels, offices airports, stores, hospitals schools and many more.

OPTI FRAMES

Frame Colour

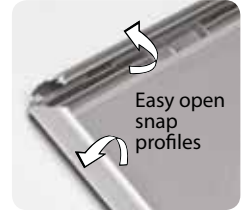
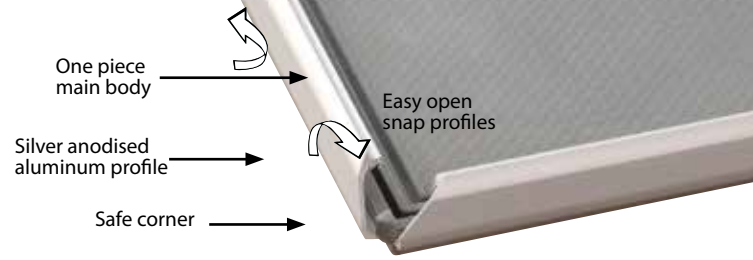
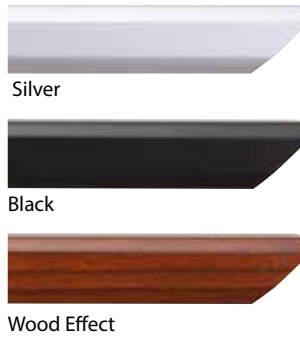

Smart design with distinctive features... "no sharp edges"
Optimised use! goes on counter, goes on wall...

Low cost snap frames with advanced design

Multi functional use

Profile Type

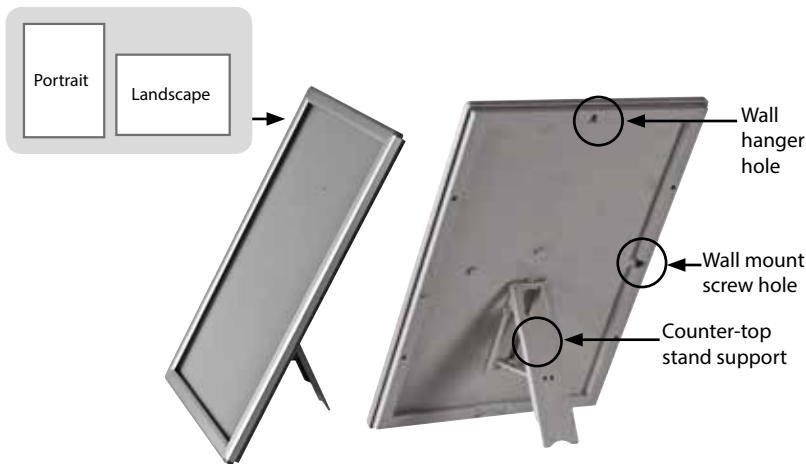
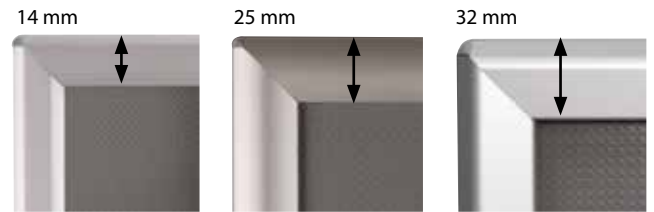

POSTER SIZE	PROFILE OPTIONS						Counter Support
	14 mm Profile		25 mm Profile		32 mm Profile		
	Mitred	Round	Mitred	Round	Mitred	Round	
A1	x	x	✓	✓	✓	✓	x
A2	x	x	✓	✓	x	x	x
A3	x	x	✓	✓	x	x	x
A4	✓	✓	✓	✓	x	x	✓
A5	✓	✓	x	x	x	x	✓
A6	✓	✓	x	x	x	x	✓
B2	x	x	✓	✓	✓	✓	x
5"X7"	✓	x	x	x	x	x	✓
8"X10"	✓	x	x	x	x	x	✓
8,5"X11"	x	x	✓	x	x	x	✓
11"X17"	x	x	✓	x	x	x	x

Opti Frame can be used for signage needs of many locations;

Patent: PCT/TR06/000018 - WO 2007/126397 - EP 2016574 - DE 20 2006 020 145 - US 2009/211134 - AU 2006342800 - CN 101473363 - CA 2654307 - UA 2008 13893 - EA 200802174/26 - IN WO 2007/126397 - ZA 2008/09638 - TR 2007 05704 - OHIM 831235-0001,2,3,4

Opti Frame Family





Silver Round

Silver Mitred

Black

Wood

PROFILE : 14 mm 45° - 14 mm Round

MITREDSILVER	ROUND SILVER	BLACK	WOOD	POSTER	DESCRIPTION
UCP145N0A4	UCP140N0A4	-	-	210 X 297 mm	Without support
UCP145N1A4	UCP140N1A4	-	-	210 X 297 mm	With support
UCP145N000	-	-	-	203 X 254 mm	Without support
UCP145N100	-	-	-	203 X 254 mm	With support
UCP145N0A5	UCP140N0A5	UCP145B0A5	UCP145W0A5	148 X 210 mm	Without support
UCP145N0A6	UCP140N0A6	UCP145B0A6	UCP145W0A6	105 X 148 mm	Without support
UCP145N1A5	UCP140N1A5	UCP145B1A5	UCP145W1A5	148 X 210 mm	With support
UCP145N1A6	UCP140N1A6	UCP145B1A6	UCP145W1A6	105 X 148 mm	With support
UCP145N057	-	-	-	127 X 178 mm	Without support
UCP145N157	-	-	-	127 X 178 mm	With support



PROFILE : 25 mm 45° - 25 mm Round

MITREDSILVER	ROUND SILVER	BLACK	WOOD	POSTER	DESCRIPTION
UCP255N0B2	UCP250N0B2	-	-	500 X 700 mm	Without support
UCP255N0A1	UCP250N0A1	-	-	594 X 841 mm	Without support
UCP255N0A4	UCP250N0A4	UCP255B0A4	UCP255W0A4	210 X 297 mm	Without support
UCP255N1A4	UCP250N1A4	UCP255B1A4	UCP255W1A4	210 X 297 mm	With support
UCP255N0A3	UCP250N0A3	-	-	297 X 420 mm	Without support
UCP255N0A2	UCP250N0A2	-	-	420 X 594 mm	Without support



PROFILE : 32 mm 45° - 32 mm Round

MITRED ARTICLE	ROUND ARTICLE	POSTER
UCP325N0B2	UCP320N0B2	500 X 700 mm
UCP325N0A1	UCP320N0A1	594 X 841 mm



PROFILE : 14 mm 45° - 14 mm Round

ARTICLE	COLOUR	POSTER
UCP145E1A4	RAL 6029-Green	210 X 297 mm
UCP145E1A5	RAL 6029-Green	148 X 210 mm
UCP145E1A6	RAL 6029-Green	105 X 148 mm
UCP145H1A4	RAL 9003-White	210 X 297 mm
UCP145H1A5	RAL 9003-White	148 X 210 mm
UCP145H1A6	RAL 9003-White	105 X 148 mm
UCP145L1A4	RAL 5002-Blue	210 X 297 mm
UCP145L1A5	RAL 5002-Blue	148 X 210 mm
UCP145L1A6	RAL 5002-Blue	105 X 148 mm
UCP145R1A4	RAL 3020-Red	210 X 297 mm
UCP145R1A5	RAL 3020-Red	148 X 210 mm
UCP145R1A6	RAL 3020-Red	105 X 148 mm
UCP145Y1A4	RAL 1021-Yellow	210 X 297 mm
UCP145Y1A5	RAL 1021-Yellow	148 X 210 mm
UCP145Y1A6	RAL 1021-Yellow	105 X 148 mm
UCP145B1A4	RAL 9005-Black	210 X 297 mm
UCP145B1A5	RAL 9005-Black	148 X 210 mm
UCP145B1A6	RAL 9005-Black	105 X 148 mm

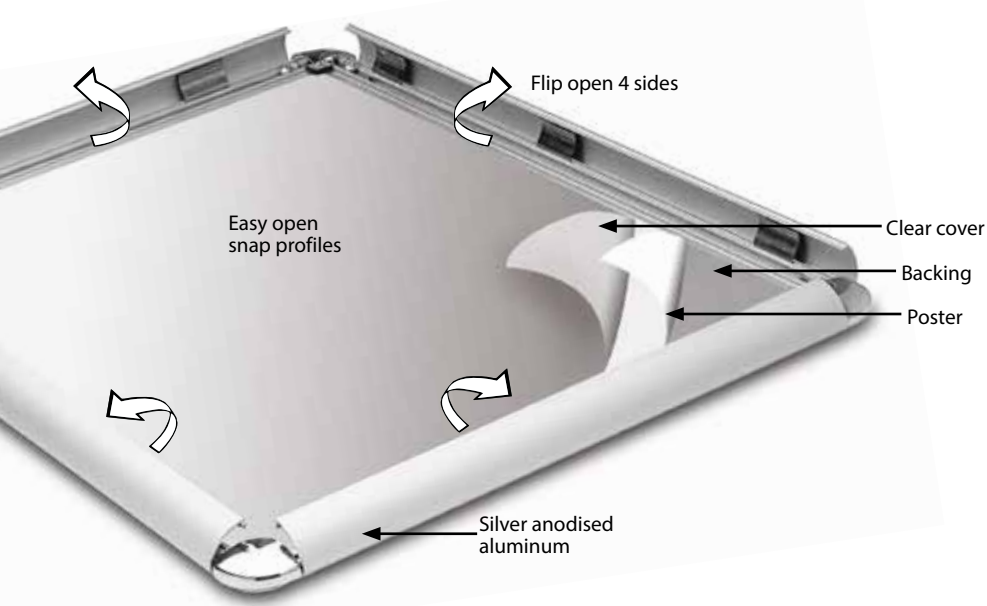

Large selection of Poster Frames are offered from 15mm to 46mm in mitred and round corners with different profile finishing such as silver, gold, chrome, black, wood and stainless. It is easy to change the poster with snap-open profiles. Profile is suitable for branding. Ready for wall mounting portrait or landscape. It provides professional solution for advertising in any trade area.

SNAP FRAMES

Easy open snap profiles
Flip open 4 sides
Silver anodised aluminum
RAL colour available

Profile Type

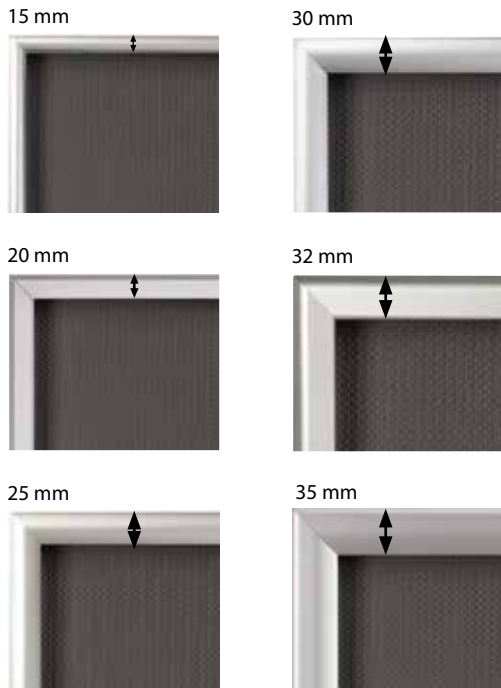

Corner Types



Frame Colour

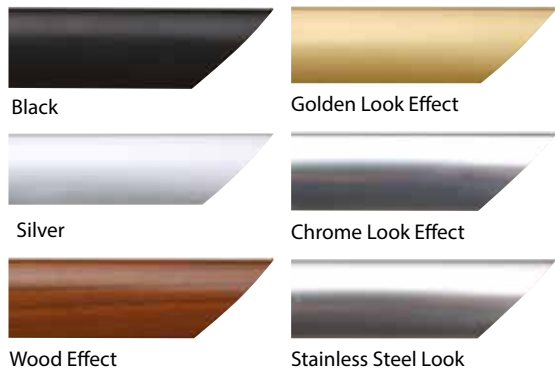

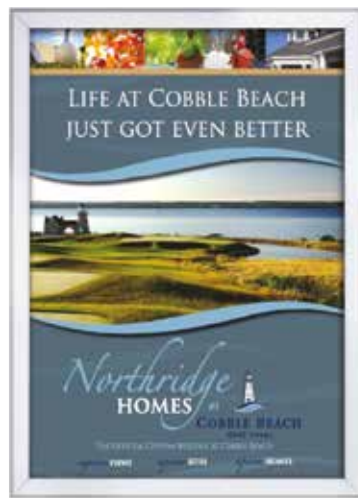
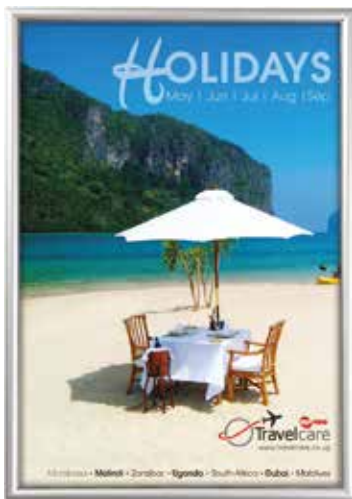

PROFILE : 15 mm 45°

ARTICLE	POSTER
UCN155NOA5	148 X 210 mm
UCN155NOA4	210 X 297 mm
UCN155NOA3	297 X 420 mm
UCN155NOA2	420 X 594 mm
UCN155NOA1	594 X 841 mm
UCN155NOB2	500 X 700 mm
UCN155NOB1	700 X 1000 mm
UCN155NO23	508 X 762 mm

PROFILE : 20 mm 45°

ARTICLE	POSTER
UCN205NOA4	210 X 297 mm
UCN205NOA3	297 X 420 mm
UCN205NOA2	420 X 594 mm
UCN205NOA1	594 X 841 mm
UCN205NOB2	500 X 700 mm
UCN205NOB1	700 X 1000 mm
UCN205NO23	508 X 762 mm
UCN205NO34	762 X 1016 mm

PROFILE : 25 mm 45° - 25 mm Round

GOLDEN	CHROME	STAINLESS	POSTER
UCN255GOA4	UCN255KOA4	UCN255SOA4	210 X 297 mm
UCN255GOA3	UCN255KOA3	UCN255SOA3	297 X 420 mm
UCN255GOA2	UCN255KOA2	UCN255SOA2	420 X 594 mm
UCN255GOA1	UCN255KOA1	UCN255SOA1	594 X 841 mm
UCN255GOB2	UCN255KOB2	UCN255SOB2	500 X 700 mm
UCN255GOB1	UCN255KOB1	UCN255SOB1	700 X 1000 mm
UCN255GO23	UCN255K023	UCN255SO23	508 X 762 mm
UCN255GO34	UCN255K034	UCN255SO34	762 X 1016 mm
UCN255GO46	UCN255K046	UCN255SO46	1016 X 1524 mm



PROFILE : 25 mm 45° - 25 mm Round

MITRE SILVER	ROUND SILVER	BLACK	WOOD	POSTER
UCN255NOA4	UCN250NOA4	UCN255BOA4	UCN255WOA4	210 X 297 mm
UCN255NOA3	UCN250NOA3	UCN255BOA3	UCN255WOA3	297 X 420 mm
UCN255NOA2	UCN250NOA2	UCN255BOA2	UCN255WOA2	420 X 594 mm
UCN255NOA1	UCN250NOA1	UCN255BOA1	UCN255WOA1	594 X 841 mm
UCN255NOB2	UCN250NOB2	UCN255BOB2	UCN255WOB2	500 X 700 mm
UCN255NOB1	UCN250NOB1	UCN255BOB1	UCN255WOB1	700 X 1000 mm
UCN255NO23	UCN250NO23	UCN255BO23	UCN255WO23	508 X 762 mm
UCN255NO34	UCN250NO34	UCN255BO34	UCN255WO34	762 X 1016 mm
UCN255NO46	UCN250NO46	UCN255BO46	UCN255WO46	1016 X 1524 mm



UYUP057000
Counter support
available. Suitable for
both landscape & portrait.

PROFILE : 30 mm 45° - 30 mm Round

MITRE SILVER	ROUND SILVER	POSTER
UCN305NOA4	UCN300NOA4	210 X 297 mm
UCN305NOA3	UCN300NOA3	297 X 420 mm
UCN305NOA2	UCN300NOA2	420 X 594 mm
UCN305NOA1	UCN300NOA1	594 X 841 mm
UCN305NOB2	UCN300NOB2	500 X 700 mm
UCN305NOB1	UCN300NOB1	700 X 1000 mm
UCN305NO23	UCN300NO23	508 X 762 mm
UCN305NO34	UCN300NO34	762 X 1016 mm
UCN305NO46	UCN300NO46	1016 X 1524 mm



PROFILE : 45 mm 45°

ARTICLE	POSTER
UCN455N0A3	297 X 420 mm
UCN455N0A2	420 X 594 mm
UCN455N0A1	594 X 841 mm
UCN455N0A0	841 X 1189 mm
UCN455N0B2	500 X 700 mm
UCN455N0B1	700 X 1000 mm
UCN455N0B0	1000 X 1400 mm
UCN455N023	508 X 762 mm
UCN455N034	762 X 1016 mm
UCN455N046	1016 X 1524 mm

PROFILE : 32 mm 45° - 32 mm Round

MITRED ARTICLE	ROUND ARTICLE	POSTER
UCN325N0A3	UCN320N0A3	297 X 420 mm
UCN325N0A2	UCN320N0A2	420 X 594 mm
UCN325N0A1	UCN320N0A1	594 X 841 mm
UCN325N0A0	UCN320N0A0	841 X 1189 mm
UCN325N0B2	UCN320N0B2	500 X 700 mm
UCN325N0B1	UCN320N0B1	700 X 1000 mm
UCN325N0B0	UCN320N0B0	1000 X 1400 mm
UCN325N023	UCN320N023	508 X 762 mm
UCN325N034	UCN320N034	762 X 1016 mm
UCN325N046	UCN320N046	1016 X 1524 mm

PROFILE : 46 mm 45° - 46 mm Round

MITRED ARTICLE	ROUND ARTICLE	POSTER
UCN465N0A3	UCN460N0A3	297 X 420 mm
UCN465N0A2	UCN460N0A2	420 X 594 mm
UCN465N0A1	UCN460N0A1	594 X 841 mm
UCN465N0A0	UCN460N0A0	841 X 1189 mm
UCN465N0B2	UCN460N0B2	500 X 700 mm
UCN465N0B1	UCN460N0B1	700 X 1000 mm
UCN465N0B0	UCN460N0B0	1000 X 1400 mm
UCN465N023	UCN460N023	508 X 762 mm
UCN465N034	UCN460N034	762 X 1016 mm
UCN465N046	UCN460N046	1016 X 1524 mm

PROFILE : 38 mm 45°

ARTICLE	POSTER
UCN385N0A3	297 X 420 mm
UCN385N0A2	420 X 594 mm
UCN385N0A1	594 X 841 mm
UCN385N0A0	841 X 1189 mm
UCN385N0B2	500 X 700 mm
UCN385N0B1	700 X 1000 mm
UCN385N023	508 X 762 mm
UCN385N034	762 X 1016 mm



Safe edges



PROFILE : 40 mm 45°

ARTICLE	POSTER
UCF405N0A4	210 X 297 mm
UCF405N0A3	297 X 420 mm
UCF405N0A2	420 X 594 mm
UCF405N0A1	594 X 841 mm
UCF405N0A0	841 X 1189 mm
UCF405N0B2	500 X 700 mm
UCF405N0B1	700 X 1000 mm
UCF405N0B0	1000 X 1400 mm
UCF405N023	508 X 762 mm
UCF405N034	762 X 1016 mm
UCF405N046	1016 X 1524 mm

PROFILE : 32 mm Safe Corner

ARTICLE	POSTER
UCN321N0A3	297 X 420 mm
UCN321N0A2	420 X 594 mm
UCN321N0A1	594 X 841 mm
UCN321N0A0	841 X 1189 mm
UCN321N0B2	500 X 700 mm
UCN321N0B1	700 X 1000 mm
UCN321N0B0	1000 X 1400 mm
UCN321N023	508 X 762 mm
UCN321N034	762 X 1016 mm
UCN321N046	1016 X 1524 mm

Fancy Frame, with a snap open design, is a simple to use framing system that makes changing graphics easy. The Fancy Frames are in different sizes and fits in decorative use of picture frames serving the needs of advertisers and decorators. These clip frames differ from conventional snap frame designs due to the decorative form. This decorative design catches viewer's attention on the displayed advertisements. Having a more stylish design than traditional models, these picture frames will capture the eyes within any commercial environment. Suitable to use in shops, retail stores, restaurants, hotel receptions, banks and waiting areas. Anti-glare poster cover sheet.

FANCY FRAME



new

Basic ECO snap frame only in size A4 210x297 mm, with 25 mm profile and mitered corners. These frames are suitable for indoors only. Including PET sheet. Delivered in box with 10 pieces.

BASIC ECO SNAP FRAME



PROFILE : 25 mm mitered

ARTICLE	DIN	POSTER
UCB255N0A4x2000	A4	210 X 297 mm

2 colours in 1 frame

Paper boards is a snap open design, paper holder. Suitable for indoor use and in portrait position. Provided with 2 clear plastic clips for each paper, one product can present 4x A4, 6x A4 or 9x A4 options. 2 colour presence serve different needs & design of environment. Paperboard is suitable for office use, as announcement boards, schools, markets and hospitals. Anti-glare poster cover sheet.

PAPER BOARD



Outer profiles black, inner profiles silver



PROFILE : 40 mm 45°

ARTICLE	CAPACITY	DESCRIPTION
UPB405BN04	4 X A4	Black- Silver
UPB405BN06	6 X A4	Black- Silver
UPB405BN09	9 X A4	Black- Silver
UPB405NB04	4 X A4	Silver-Black
UPB405NB06	6 X A4	Silver-Black
UPB405NB09	9 X A4	Silver-Black



PROFILE : 42 mm 45°

ARTICLE	POSTER
UCA42N00F1	600 X 800 mm
UCA42N00F0	800 X 1200 mm
UCA42N00B1	700 X 1000 mm
UCA42N00B0	1000 X 1400 mm
UCA42N0616	600 X 1600 mm
UCA42N1216	1200 X 1600 mm



Autoboard Frame is one of the best and leading vehicle advertisements. It is made of a 42 mm silver-anodized security profile fitted in the sides of vehicles such as trucks, buses, ice-cream vans, etc.. In order to hang the Autoboard Frame on the vehicle, you just need to fix the screws through the channel of the frame. It is easy to change the poster and with the help of the hinges the PET front cover remains constantly fixed and stable. The protective PET front cover is standard. The rear profile of the Autoboard Frame includes water leakage holes. Anti-glare poster cover sheet included.

AUTOBOARD FRAME

- Ideal for medium-sized posters
- It is a secure hard-to-open profile.
- Suitable for open-air use or highly frequented areas accessible to the public.
- Natural Silver-anodized and various RAL colors are available.
- Anti-glare poster cover sheet.

SECURITY FRAMES



UYUP047100
Levertool for
42 mm



UYUP047000
Levertool for
25 & 32 mm



25 mm

32 mm

42 mm

PROFILE : 40 mm 45°

25 mm	32 mm	42 mm	POSTER
UCZ255N0A4	-	-	210 X 297 mm
UCZ255N0A3	UCZ325N0A3	UCZ425N0A3	297 X 420 mm
UCZ255N0A2	UCZ325N0A2	UCZ425N0A2	420 X 594 mm
UCZ255N0A1	UCZ325N0A1	UCZ425N0A1	594 X 841 mm
-	UCZ325N0A0	UCZ425N0A0	841 X 1189 mm
UCZ255N0B2	UCZ325N0B2	UCZ425N0B2	500 X 700 mm
UCZ255N0B1	UCZ325N0B1	UCZ425N0B1	700 X 1000 mm
-	UCZ325N0B0	-	1000 X 1400 mm
UCZ255N023	UCZ325N023	UCZ425N023	508 X 762 mm
UCZ255N034	UCZ325N034	UCZ425N034	762 X 1016 mm
UCZ255N046	UCZ325N046	UCZ425N046	1016 X 1524 mm



Levertool to open the security profiles is sold separately. Please don't forget to order.

Security system

The Window Frame system is available in 25 mm profile. You can easily change the poster by opening the front profile. 2 anti-reflex PET covers use, poster can be displayed both indoor & outdoor. The system includes decorative back profile to hide the double-sided adhesive tape which holds the frame to the window. Anti-glare poster cover sheet.

WINDOW FRAMES



25 mm

32 mm

PROFILE : 25 mm 45° - 32 mm 45°

25 mm	32 mm	POSTER
UCW255N4A4	UCW325N4A4	210 X 297 mm
UCW255N4A3	UCW325N4A3	297 X 420 mm
UCW255N4A2	UCW325N4A2	420 X 594 mm
UCW255N4A1	UCW325N4A1	594 X 841 mm
-	UCW325N4A0	841 X 1189 mm
UCW255N4B2	UCW325N4B2	500 X 700 mm
UCW255N4B1	UCW325N4B1	700 X 1000 mm
-	UCW325N4B0	1000 X 1400 mm
UCW255N423	UCW325N423	508 X 762 mm
UCW255N434	UCW325N434	762 X 1016 mm
UCW255N446	UCW325N446	1016 X 1524 mm



Double-sided tape on the back frame



Decorative profile application

Plastic injected Window Sign is a practical solution for places where messages changes very often. It is suitable for posters printed double sided or 2 posters printed in single sided. Matching decorative profiles complete the view from outside the window. Available in Black and Grey as standard. Anti-glare poster cover sheet.

WINDOW SIGN

7 mm depth



Magnets

Magnets

Hinge

Patent Pending
OHIM DM/084 128

MATERIAL: Plastic injected

ARTICLE	POSTER	DESCRIPTION
UCWP10B0A4	210 X 297 mm	Magnetic / Ral 9005
UCWP10N0A4	210 X 297 mm	Magnetic / Ral 9006

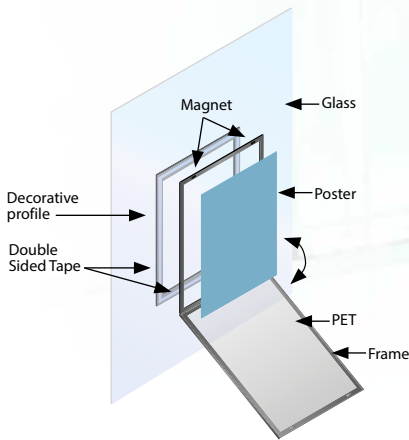

IP55 APPROVED

- Suitable for use under outdoor conditions.
- Ideal for poster of every size.
- Natural Silver-anodized with different available in RAL colors.
- Mitred corners.
- There are water drainage holes on the product (for details see assembly sheet).
- Anti-glare poster cover sheet.

WEATHERPROOF FRAMES

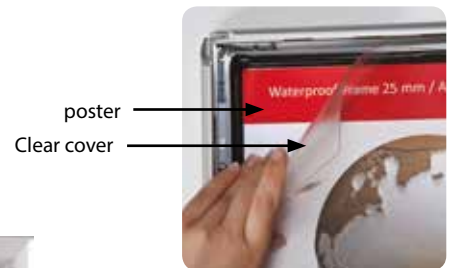

poster

Clear cover

Sealing rubber

Water drainage holes

PROFILE :25 mm 45° - 35 mm 45°

25 mm	35 mm	POSTER
UCH255N0A4	UCH355N0A4	210 X 297 mm
UCH255N0A3	UCH355N0A3	297 X 420 mm
UCH255N0A2	UCH355N0A2	420 X 594 mm
UCH255N0A1	UCH355N0A1	594 X 841 mm
-	UCH355N0A0	841 X 1189 mm
UCH255N0B2	UCH355N0B2	500 X 700 mm
UCH255N0B1	UCH355N0B1	700 X 1000 mm
-	UCH355N0B0	100 X 1400 mm
UCH255N023	UCH355N023	508 X 762 mm
UCH255N034	UCH355N034	762 X 1016 mm
-	UCH355N046	1016 X 1524 mm

25 mm

Patent Pending
TR 2006 06254
PCT/TR06/000064

35 mm

IP55 APPROVED

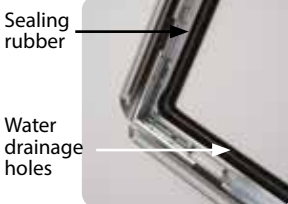

PROFILE : 35 mm 45°

ARTICLE	POSTER
UCV355N0A4	210 X 297 mm
UCV355N0A3	297 X 420 mm
UCV355N0A2	420 X 594 mm
UCV355N0A1	594 X 841 mm
UCV355N0A0	841 X 1189 mm
UCV355N0B2	500 X 700 mm
UCV355N0B1	700 X 1000 mm
UCV355N0B0	1000 X 1400 mm
UCV355N023	508 X 762 mm
UCV355N034	762 X 1016 mm
UCV355N046	1016 X 1524 mm

Patent Pending
TR 2006 06254
PCT/TR06/000064

The four sides of the lockable frame open sequentially. The last profile is held in place with a screw on top that can be opened with its key. This system ensures your poster is never accessed by unauthorized third parties. Suitable for outdoor use. The product has water drainage holes (for details see assembly sheet). Anti glare poster cover sheet.

LOCKABLE WEATHERPROOF FRAME

The lockable Window Frame system is available in a 32 mm profile. Thanks to 2 anti-reflex PET covers, your posters can be displayed both indoor & outdoor. The system includes a decorative back profile to hide the double-sided adhesive tape holding the frame up to the window. As the tape surrounds the whole frame, it prevents any water flow from the outside in order to keep your poster dry. The profiles open sequentially and the lockable system ensures your poster is never accessed by unauthorized third parties. Antiglare poster cover sheet.

PROFILE : 32 mm 45°

ARTICLE	POSTER
UCK325N4A4	210 X 297 mm
UCK325N4A3	297 X 420 mm
UCK325N4A2	420 X 594 mm
UCK325N4A1	594 X 841 mm
UCK325N4A0	841 X 1189 mm
UCK325N4B2	500 X 700 mm
UCK325N4B1	700 X 1000 mm
UCK325N4B0	1000 X 1400 mm
UCK325N423	508 X 762 mm
UCK325N434	762 X 1016 mm
UCK325N446	1016 X 1524 mm

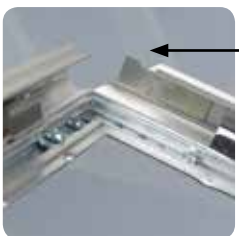

Interior corner lock component



Locking frame with allen key

LOCKABLE WINDOW FRAME

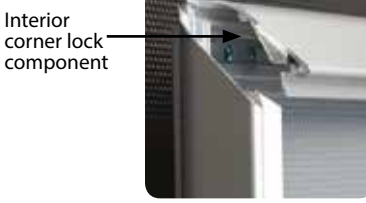

PROFILE : 32 mm 45°

ARTICLE	POSTER
UCL325N0A4	210 X 297 mm
UCL325N0A3	297 X 420 mm
UCL325N0A2	420 X 594 mm
UCL325N0A1	594 X 841 mm
UCL325N0A0	841 X 1189 mm
UCL325N0B2	500 X 700 mm
UCL325N0B1	700 X 1000 mm
UCL325N0B0	1000 X 1400 mm
UCL325N023	508 X 762 mm
UCL325N034	762 X 1016 mm
UCL325N046	1016 X 1524 mm

The four sides of the lockable frame open sequentially. The last profile is held in place with a screw on top that can be opened with its key. This system ensures your poster is never accessed by unauthorized third parties. Anti glare poster cover sheet.

LOCKABLE SNAP FRAME

Optional accessories



Free hanging hook, comes with frames in standard.



A suitable way to present your messages and posters in spaces where you have no wall mounting possibilities. If suspended from the ceiling via wire cables in front of shop windows, the posters can be viewed both from the inside and from the outside. Anti glare poster cover sheet.

DOUBLE SIDED SNAP FRAMES

PROFILE : 25 mm 45° - 32 mm 45° / 32 mm round

MITRED 25 mm	MITRED 32 mm	ROUND 32 mm	POSTER
UCD255N2A4	-	-	210 X 297 mm
UCD255N2A3	UCD325N2A3	UCD320N2A3	297 X 420 mm
UCD255N2A2	UCD325N2A2	UCD320N2A2	420 X 594 mm
UCD255N2A1	UCD325N2A1	UCD320N2A1	594 X 841 mm
-	UCD325N2A0	UCD320N2A0	840 X 1189 mm
UCD255N2B2	UCD325N2B2	UCD320N2B2	500 X 700 mm
UCD255N2B1	UCD325N2B1	UCD320N2B1	700 X 1000 mm
UCD255N223	UCD325N223	UCD320N223	508 X 762 mm
UCD255N234	UCD325N234	UCD320N234	762 X 1016 mm
UCD255N246	UCD325N246	UCD320N246	1016 X 1524 mm

Ceiling hangers are optional.

Ceiling hangers are optional.



25 mm



32 mm



Optional accessories



UYAA001100



UYAA007000



UYAA006000



UYAA001000



UYAA002100



UYAA002200



UYAA000000



UYAA004000



UYAA005000

Slide-in frames are practical to change posters by sliding them in & out. Ready for use with 2 PET covers. It has single and double sided options as well as counter options. It is recommended for shops, petrol stations, offices, hotels, travel agents and similar trade area.

SLIDE-IN FRAMES



A5 Size Portrait



Double sided tape



A4 Size Landscape

Counter

MATERIAL : Silver anodised aluminium

LANDSCAPE	PORTRAIT	POSTER
UCA255N2A5	UCA255N1A5	210 X 148 mm
UCA255N2A4	UCA255N1A4	297 X 210 mm
UCA255N2A3	UCA255N1A3	420 X 297 mm

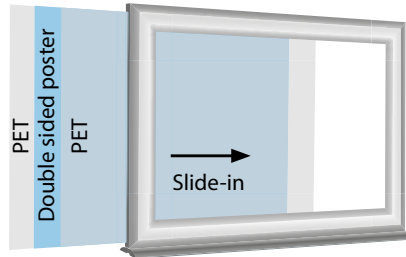

Portrait

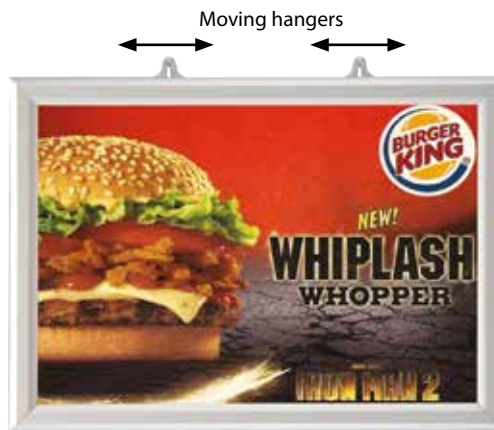

Landscape

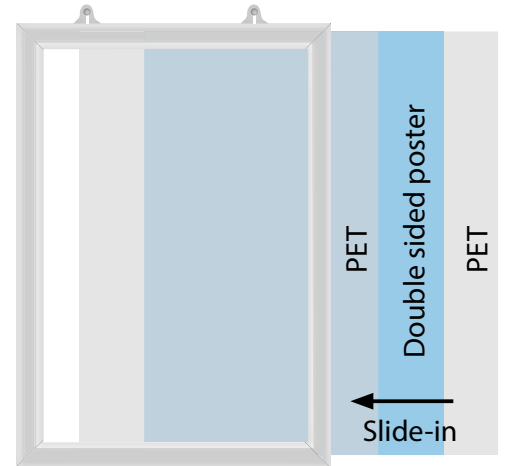

Double Sided

MATERIAL : Silver anodised aluminium

PORTRAIT	LANDSCAPE	POSTER
UCS255N1A4	UCS255N2A4	210 X 297mm
UCS255N1A3	UCS255N2A3	297 X 420 mm
UCS255N1A2	UCS255N2A2	420 X 594 mm
UCS255N1A1	UCS255N2A1	594 X 841 mm
UCS255N1B2	UCS255N2B2	500 X 700 mm
UCS255N123	UCS255N223	508 X 762 mm



Single Sided

MATERIAL : Silver anodised aluminium

ARTICLE	POSTER
UCS245N1A4	210 X 297 mm
UCS245N1A3	297 X 420 mm
UCS245N1A2	420 X 594 mm
UCS245N1A1	594 X 841 mm
UCS245N1B2	500 X 700 mm
UCS245N123	508 X 762 mm

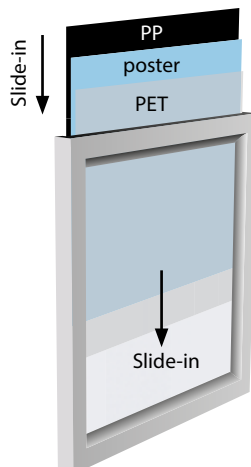

Color options :
Silver-anodized & Black

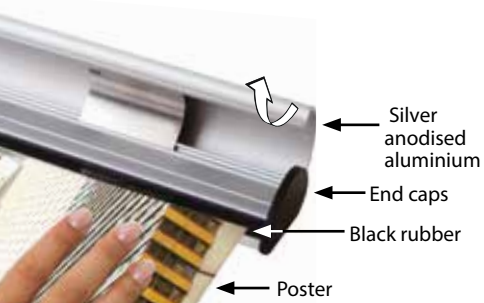

Silver anodised aluminium
End caps
Black rubber
Poster



Moving hangers

One set includes the upper and the bottom profiles with the end caps on both profiles and the hangers on the top profile. Improved rubber foam for poster suspension.

POSTER SNAP

MATERIAL : Silver anodised aluminium

ARTICLE	POSTER
UPT26SN021	210 mm
UPT26SN030	300 mm
UPT26SN042	420 mm
UPT26SN050	500 mm
UPT26SN060	600 mm
UPT26SN070	700 mm
UPT26SN085	850 mm
UPT26SN100	1000 mm

Patent Pending
TR 2005 01301



Moving hangers

Suitable for heavier and bigger posters in thickness 50 micron - 500 micron. One set includes the end caps on both profiles and the hangers on the top profile.

POSTER CLAMP

MATERIAL : Silver anodised aluminium

ARTICLE	POSTER
UPC00SN021	210 mm
UPC00SN030	300 mm
UPC00SN042	420 mm
UPC00SN050	500 mm
UPC00SN060	600 mm
UPC00SN070	700 mm
UPC00SN085	850 mm
UPC00SN100	1000 mm



End caps
Silver anodised aluminium
Poster

A lightweight frame that stretches the poster from 4 corners. The poster can be easily changed with the help of plastic clips. It is available in standard anodized silver. Other colors are available upon request. Two plastic hangers for both wall mounting and ceiling suspension are included. The plastic clips stretched from the corners place the poster in the center without spoiling or harming the poster paper.

STRETCH FRAME



Moving hangers

MATERIAL : Silver anodised aluminium

ARTICLE	POSTER
UPSCN000A4	210 X 297 mm
UPSCN000A3	297 X 420 mm
UPSCN000A2	420 X 594 mm
UPSCN000A1	594 X 841 mm
UPSCN000B2	500 X 700 mm
UPSCN000B1	700 X 1000 mm

Poster peg spiral
Poster
Poster peg

A newly created series of poster clamps offers competitive solutions. Suitable for posters in thickness 50 micron / 500 micron. One set includes end caps on both profiles and hangers on the top profile.

NEWAGE POSTER CLAMP

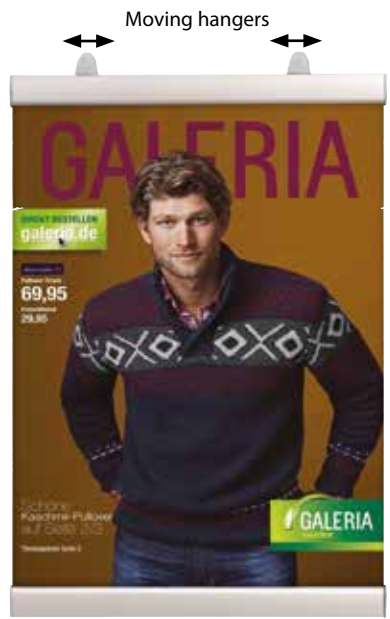

Moving hangers

MATERIAL : Silver anodised aluminium

ARTICLE	POSTER
UPC10SN021	210 mm
UPC10SN030	300 mm
UPC10SN042	420 mm
UPC10SN050	500 mm
UPC10SN060	600 mm
UPC10SN070	700 mm
UPC10SN085	850 mm
UPC10SN100	1000 mm
UPC10SN120	1200 mm



Moving hangers
Silver anodised aluminium
25 mm

Suitable for heavier and bigger posters in thickness 10 micron - 500 micron. A double-sided poster holder. One set includes end caps on both profiles and hangers on the top profile. The product is supplied with 40 mm see/clear co-extrusion components inside which hold the poster.

POSTER FAST

MATERIAL : Silver anodised aluminium

ARTICLE	POSTER
UPF21SN021	210 mm
UPF21SN030	300 mm
UPF21SN042	420 mm
UPF21SN050	500 mm
UPF21SN060	600 mm
UPF21SN070	700 mm
UPF21SN085	850 mm
UPF21SN100	1000 mm
UPF21SN120	1200 mm

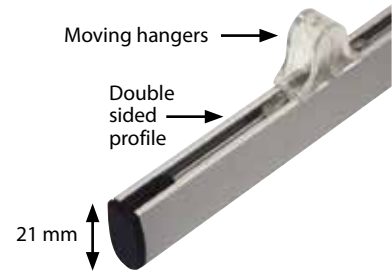

Double sided



Wall fixing screws of Outdoor Flap Gripper are included in the pack which are CE certified multi-expansion long plugs. Special anti-corrosion coated screw is made of zinc coated steel and plastic sleeve made of high quality of nylon. It is confirmed for outdoor fixing on various exterior building surfaces such as concrete, solid or honeycomb brick, hollow dense or hollow light aggregate block, aerated concrete and solid stone.

Panel: 5 mm Plastech PVC Foam

ARTICLE	POSTER SIZE
UYOFG10610	620 X 1000 mm
UYOFG10612	620 X 1200 mm
UYOFG10615	620 X 1500 mm

MATERIAL : Silver anodised aluminium - excluding panel

ARTICLE	POSTER SIZE
UOFG00N100	620 X 1000 mm
UOFG00N120	620 X 1200 mm
UOFG00N150	620 X 1500 mm

Outdoor Flap Gripper offers innovative solutions for your advertising needs. It is designed to mount rigid panels onto outer walls using both sides of display poster. Then it gets the attention of 2-way traffic. It accepts rigid panels in 5mm thicknesses. EN certified wall fixing increase the security of the product in use. Fixing is covered by plastic end caps to provide clean finish to the product.

OUTDOOR FLAP GRIPPER



Suitable for use in open-air spaces or public areas such as schools, offices, hospitals, etc. 15 mm or 26 mm profile options are available. An anti-reflex PET cover protects your documents from tearing and suffering damage. Fixing availability with screws or adhesive tape both in landscape and portrait position.

DOOR SIGNS



15 mm



26 mm

HOLLAND®
SNAP FRAME
Sign & more

peel & stick

PROFILE: 15 mm

ARTICLE	POSTER
UDS150N0A7	74 X 105 mm
UDS150N0A6	105 X 148 mm
UDS150N0A5	148 X 210 mm
UDS150N0A4	210 X 297 mm
UDS150N0A3	99 X 210 mm

PROFILE: 26 mm

ARTICLE	POSTER
UDS0001050	50 X 148 mm
UDS0002050	105 X 148 mm
UDS0003050	105 X 297 mm
UDS0004050	148 X 210 mm
UDS0005050	210 X 297 mm

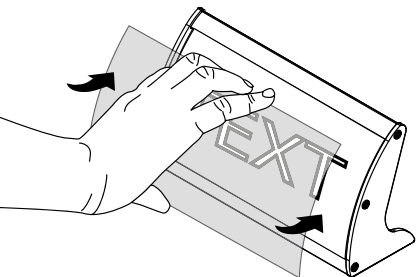

MATERIAL : Silver anodised aluminium

ARTICLE	POSTER SIZE
UMDS740N15	74 X 150 mm
UMDS740N20	74 X 200 mm
UMDS740N25	74 X 250 mm
UMDS105N15	105 X 150 mm
UMDS105N20	105 X 200 mm
UMDS105N25	105 X 250 mm
UMDS105N30	105 X 300 mm
UMDS148N20	148 X 200 mm
UMDS148N25	148 X 250 mm
UMDS148N30	148 X 300 mm



Suction Cup / UYAA006010

Offering a complete range, aluminium wall sign profiles are design to enable usage on a counter to match Wall Signs. Desktop Sign is fixed to a convenient reading angle to be seen by the customers easily. It is suitable for receptions, restaurants, cafés and many more. It is a practical product to change the message very often.

DESKTOP SIGN

Fast and Simple! Aluminium wall sign profiles are designed to create horizontally curved double sided suspended signs. Using your stock of single sided profiles, product offerings can be increased to double sided suspension style. Double Sided Wall Sign is suitable as directional signs, way finding. Suspension cables enclosed enables flexible positioning of the sign. Black endcaps complete the look.

DOUBLE SIDED WALL SIGN



Maximum recommended length: 500 mm

WALL SIGN DOUBLE SIDED: Silver anodised aluminium

	SINGLE LAYER	2- LAYER	3-LAYER	4- LAYER	5- LAYER
74 mm	✓	✓	✓	✓	✓
105 mm	✓	✓	✓	✓	
148 mm	✓	✓	✓		

MATERIAL : Silver anodised aluminium

ARTICLE	DESCRIPTION
UYPDS00001	Double Sided Suspension Set / 2x4 m fishnet & 2xCeiling Hanger
UYPDS00002	Double Sided Fixing Set

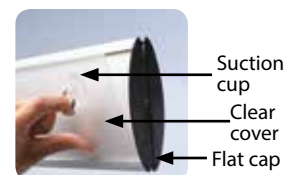

Fixing components (UYPDS00002) Suspension set (UYPDS00001)

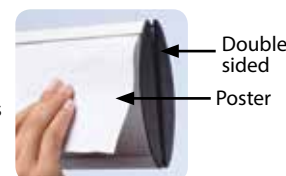

Fast and simple!

The Wall Sign system is a perfect solution for wall posters and signs. It allows clear visibility for the poster and has an aesthetic curved shape. The stylish curved Wall Sign system in various sizes suits the room sign and way finding needs within the building. Designed for paper inserts and is offered in variety of profile types to match different projects. The front cover is anti-reflex which is flexed into place after inserting the paper. Poster inserts can be created from common inkjet or laser printers. Printed-paper inserts may be in portrait or landscape outline and various sizes fitting in 4 profile types.

WALL SIGNS



148 x 300 mm



105 x 250 mm



74 x 150 mm



52 x 150 mm



Flat cap



Suction cap



Arc cap



Double sided tape



WALL SIGN SYSTEM 52 mm

ARTICLE	Model	POSTER
UDS520NA10	Flat Endcap	52 X 100 mm
UDS520NA15	Flat Endcap	52 X 150 mm
UDS520NA20	Flat Endcap	52 X 200 mm
UDS520NA25	Flat Endcap	52 X 250 mm
UDS520NA30	Flat Endcap	52 X 300 mm
UDS520NA35	Flat Endcap	52 X 350 mm
UDS520NA40	Flat Endcap	52 X 400 mm
UDS520NA45	Flat Endcap	52 X 450 mm
UDS520NB10	Arc Endcap	52 X 100 mm
UDS520NB15	Arc Endcap	52 X 150 mm
UDS520NB20	Arc Endcap	52 X 200 mm
UDS520NB25	Arc Endcap	52 X 250 mm
UDS520NB30	Arc Endcap	52 X 300 mm
UDS520NB35	Arc Endcap	52 X 350 mm
UDS520NB40	Arc Endcap	52 X 400 mm
UDS520NB45	Arc Endcap	52 X 450 mm

WALL SIGN SYSTEM 74 mm

ARTICLE	Model	POSTER
UDS740NA15	Flat Endcap	74 X 150 mm
UDS740NA20	Flat Endcap	74 X 200 mm
UDS740NA25	Flat Endcap	74 X 250 mm
UDS740NA30	Flat Endcap	74 X 300 mm
UDS740NA35	Flat Endcap	74 X 350 mm
UDS740NA40	Flat Endcap	74 X 350 mm
UDS740NA45	Flat Endcap	74 X 450 mm
UDS740NA50	Flat Endcap	74 X 500 mm
UDS740NB15	Arc Endcap	74 X 150 mm
UDS740NB20	Arc Endcap	74 X 200 mm
UDS740NB25	Arc Endcap	74 X 250 mm
UDS740NB30	Arc Endcap	74 X 300 mm
UDS740NB35	Arc Endcap	74 X 350 mm
UDS740NB40	Arc Endcap	74 X 350 mm
UDS740NB45	Arc Endcap	74 X 450 mm
UDS740NB50	Arc Endcap	74 X 500 mm

WALL SIGN SYSTEM 105 mm

ARTICLE	Model	POSTER
UDS105NA20	Flat Endcap	105 X 250 mm
UDS105NA30	Flat Endcap	105 X 300 mm
UDS105NA35	Flat Endcap	105 X 350 mm
UDS105NA40	Flat Endcap	105 X 400 mm
UDS105NA50	Flat Endcap	105 X 500 mm
UDS105NA60	Flat Endcap	105 X 600 mm
UDS105NB25	Arc Endcap	105 X 250 mm
UDS105NB30	Arc Endcap	105 X 300 mm
UDS105NB35	Arc Endcap	105 X 350 mm
UDS105NB40	Arc Endcap	105 X 400 mm
UDS105NB50	Arc Endcap	105 X 500 mm
UDS105NB60	Arc Endcap	105 X 600 mm

WALL SIGN SYSTEM 148 mm

ARTICLE	Model	POSTER
UDS148NA30	Flat Endcap	148 X 300 mm
UDS148NA35	Flat Endcap	148 X 350 mm
UDS148NA40	Flat Endcap	148 X 400 mm
UDS148NA50	Flat Endcap	148 X 500 mm
UDS148NA60	Flat Endcap	148 X 600 mm
UDS148NA65	Flat Endcap	148 X 650 mm
UDS148NB30	Arc Endcap	148 X 300 mm
UDS148NB35	Arc Endcap	148 X 350 mm
UDS148NB40	Arc Endcap	148 X 400 mm
UDS148NB50	Arc Endcap	148 X 500 mm
UDS148NB60	Arc Endcap	148 X 600 mm
UDS148NB65	Arc Endcap	148 X 650 mm



TDFJ100C01
Chromed Toilet Signs, Handicap, Grey Panel



TDFJ92W002
Chromed Toilet Signs, Women



TDFJ92X002
Chromed Toilet Signs, Men

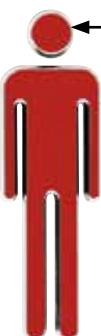

Back Side



TDFJ100W01
Chromed Toilet Signs, Women, Grey Panel



TDFJ100X01
Chromed Toilet Signs, Men, Grey Panel



Back Side

Chrome coated 3D toilet signs are available for men and women in 92 mm and clean neat finish add value to the signs. Easy to apply on the door or wall with self-adhesive tape provided on the back of each sign.

TOILET LOGO SYSTEMS

MATERIAL: Chrome

ARTICLE	HEIGHT	DESCRIPTION
TDFJ92X002	92 mm	Silver- Men
TDFJ92W002	92 mm	Silver - Women
TDFJ100X01	100 mm	Milky White - Men
TDFJ100W01	100 mm	Milky White - Women
TDFJ100C01	100 mm	Milky White - Handicap



A parking board that consists of two parts. A basic part which is made of impact-resistant plastic and a impact-resistant crystal clear toppart what you can wrap on the inside with your text/advertising. Suitable for signage in parking garages and/or car parks. Bolted to the surface, it cannot easily be modified or deleted by third parties. Fully made from impact-resistant plastic.

PARK' SIGN®



MATERIAL: Impact resistant plastic

ARTICLE	DESCRIPTION
PARKSIGNBASE	Park Sign base
PARKSIGNTOP	Park Sign top
PARKSIGNTANG#1	Park Sign tang



peel & stick

123
456
7890

Chrome coated plastic House Numbers offered in a pack 0-9. Easy to apply on various surfaces with self-adhesive tape on the back of each sign.

HOUSE NUMBER

MATERIAL: Chrome coated plastic

ARTICLE	HEIGHT	DESCRIPTION
TDFH700002	70 mm	Silver - 0-9



150x200 mm brushed Aluminium Braille Toilet Signs are plastic framed. The signs incorporated a combination of tactile text and printed text. It is available in Men and Women options. Easy to apply with self-adhesive tape provided on the back of each sign.

6X8 BARILLE SIGN

MATERIAL: Aluminium

ARTICLE	EXTERNAL (x-y)	DESCRIPTION
TDFL070002	150 X 200 mm	Silver- Men
TDFL080002	150 X 200 mm	Silver - Women

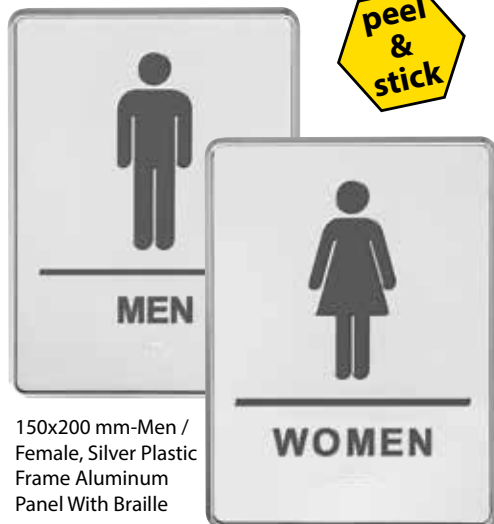

150x200 mm-Men / Female, Silver Plastic Frame Aluminum Panel With Braille



127x127 mm -No Smoking, Silver Plastic Frame Aluminum Panel With Braille



MATERIAL: Aluminium

ARTICLE	EXTERNAL (x-y)	DESCRIPTION
TDFL110002	127 X 127 mm	Silver

127x127mm brushed aluminium Braille NO SMOKING Signs are plastic framed. Easy to apply with self-adhesive tape provided on the back of each sign.

5X5 BARILLE SIGN



MATERIAL : Clear acrylic 2 mm

ARTICLE	POSTER SIZE
USMS0D00A4	297 X 420 mm
USMS0D00A3	210 X 297 mm
USMS0D00A2	420 X 594 mm

Designed as frameless, Standoff Mount Acrylic Sign is a practical display system allowing to change poster when it is still on the wall by sliding. It is suitable for environments where the advertisement or promotions are changed very often such as offices, meeting rooms, travel agents, hotels, restaurants and many more. Standoff Mount Acrylic Sign is also suitable for branding.

STANDOFF MOUNT ACRYLIC SIGN



Clear window Frame is made of 3 mm acrylic and displays the poster as double sided. There are four strong suction cups to hold the sign for displaying the poster on glass doors or windows. The printed poster are easily inserted from top and sides, and remain mounted while changing them. These clear window frames are suitable to use at shop window, store entrances, restaurants etc.

CLEAR FRAME

MATERIAL : Clear acrylic 3 mm

ARTICLE	POSTER SIZE	DESCRIPTION
UCF00D00A4	210 X 297 mm	Portrait
UCF00Y00A4	297 X 210 mm	Landscape
UCF00D00A3	297 X 420 mm	Portrait
UCF00Y0081	8,5" w X 11" h	Landscape
UCF00D0081	8,5" w X 11" h	Portrait
UCF00D0022	22" w X 28" h	Portrait
UCF00D0017	11" w X 17" h	Portrait
UCF00D0011	11" w X 14" h	Portrait





Fast Note is a product which enables you to hang your papers, notes, pictures or photos without magnets or pins. It has a slim and compact design. Thanks to the cylinders in the profile you can easily keep the paper inside. Fast Note is suitable for restaurants, agencies, studios, hospitals, hotels, conference rooms, houses and offices.

FAST NOTE

MATERIAL : Silver anodised aluminium

ARTICLE	EXTERNAL (x)	POSTER
UFN000N031	335 mm	310 mm
UFN000N050	525 mm	500 mm
UFN000N058	605 mm	580 mm
UFN000N088	905 mm	880 mm
UFN000N100	1025 mm	1000 mm
UFN000N118	1205 mm	1180 mm
UFN000N150	1525 mm	1500 mm

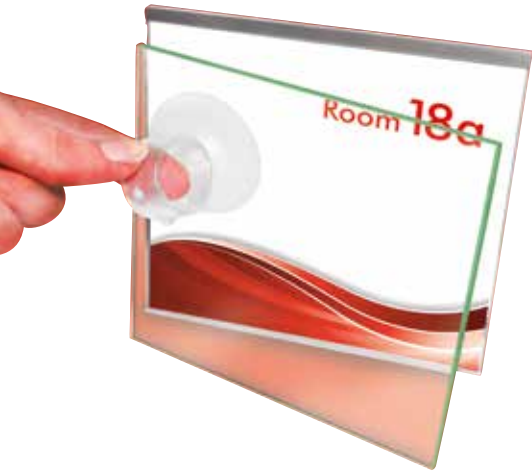

GlasFix cassette system consists of a 0.8 mm stainless steel cassette with U-shaped wide brim on top and thin edge at the bottom, including a white cardboard insert and a 0.5 mm polished 4 mm thick ESG glass plate.

GLASFIX CASSETTE SYSTEM

MATERIAL : Stainless steel

ARTICLE	POSTER	EXTERNAL
108-105-B	A6 landscape	152 X 110 X 6,7 mm
108-105-H	A6 portrait	107 X 155 X 6,7 mm
108-150-Q	150 X 150 mm	152 X 155 X 6,7 mm
108-051-B	150 X 297 mm	152 X 302 X 6,7 mm
108-210-B	A5 landscape	212 X 155 X 6,7 mm
108-210-H	A5 portrait	152 X 215 X 6,7 mm
108-297-B	A4 landscape	300 X 215 X 6,7 mm
108-297-H	A4 portrait	213 X 303 X 6,7 mm
108-420-B	A3 landscape	426 X 303 X 6,7 mm
108-420-H	A3 portrait	300 X 403 X 6,7 mm
108-594-B	A2 landscape	597 X 426 X 6,7 mm
108-594-H	A2 portrait	423 X 600 X 6,7 mm
108-840-B	A1 portrait	600 X 846 X 6,7 mm

Composition GlasFix cassette system

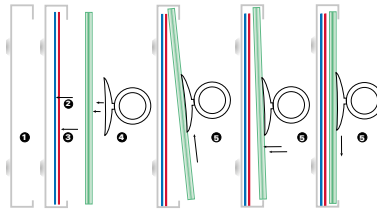
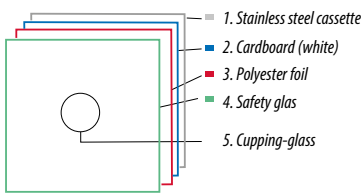

Accessories

ARTICLE	DESCRIPTION	SIZE
453-430	Pozidrive	4 X 30 mm
453-440	Pozidrive	4 X 40 mm
453-450	Pozidrive	4,5 X 50 mm
400-104	Plug	5 X 31 mm
108-950	Cupping-glass	Ø 50 mm
108-960	Adhesive plate	120 X 70 X 3 mm

The stainless steel back, depending on the size of the screen, is equipped with 4, 6 or 8 screw eyes with 6 mm holes for the implementation of the 4 mm screws. This allows up to 2 mm drill differ for each attachment point.

After mounting the STAINLESS STEEL cassette, insert the white cardboard in the cartridge to cover the inside of the back. Put the print on the white backing, preferably made on white polyester film.

After that, put the acrylic in the cassette was and press firmly to close it.

CLICKFIX CASSETTE SYSTEM



MATERIAL : Stainless steel

ARTICLE	POSTER	EXTERNAL
108-075-AC	150 X 75 mm	152 X 77 X 4,5 mm
108-105-AC	150 X 105 mm	152 X 107 X 4,5 mm
108-150-AC	150 X 150 mm	152 X 152 X 4,5 mm
108-210-AC	150 X 210 mm	152 X 212 X 4,5 mm
108-051-AC	150 X 297 mm	152 X 299 X 4,5 mm
108-297-AC	210 X 297 mm	212 X 299 X 4,5 mm
108-420-AC	297 X 420 mm	299 X 422 X 4,5 mm

Accessories

ARTICLE	DESCRIPTION	SIZE
453-430	Pozidrive	4 X 30 mm
453-440	Pozidrive	4 X 40 mm
400-104	Plug	5 X 31 mm
108-950	Cupping-glass	Ø 50 mm
108-960	Adhesive plate	120 X 70 X 3 mm

We offer various menuboards for your different use and purpose. A range of free standing menuboards and information poster stands are available as illuminated or non-illuminated. These are designed for restaurants, banks, hotel marketing or even for directional signs.

MENUBOARDS



Landscape & Portrait lock

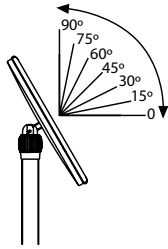

One product, two positions (landscape & portrait)

Flexible

MATERIAL : Silver anodised aluminium				
ARTICLE	H max.	H min.	POSTER	DESCRIPTION
UDMB6005A4	1205 mm	865 mm	297 X 210 mm	Landscape
	1250 mm	910 mm	210 X 297 mm	Portrait
UDMB6005A3	1250 mm	910 mm	420 X 297 mm	Landscape
	1310 mm	970 mm	297 X 420 mm	Portrait

Flexible with Fixed Height

MATERIAL : Silver anodised aluminium			
ARTICLE	Height	POSTER	DESCRIPTION
UDMB7005A4	967 mm	297 X 210 mm	Landscape
	1010 mm	210 X 297 mm	Portrait
UDMB7005A3	1014 mm	420 X 297 mm	Landscape
	1076 mm	297 X 420 mm	Portrait



One product, two positions (landscape & portrait)

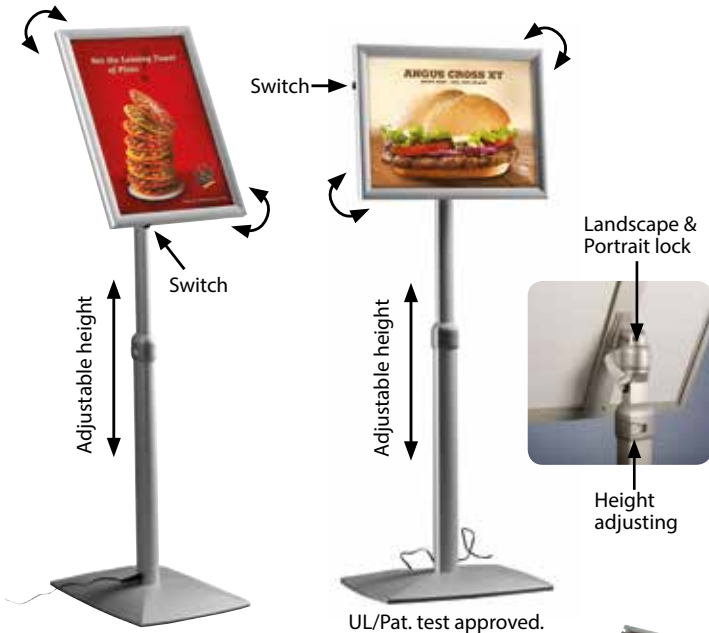

Flexible with Ledbox

MATERIAL : Silver anodised aluminium					
ARTICLE	H max.	H min.	POSTER	DESCRIPTION	LIGHTING
UFML00N0A4	1205 mm	865 mm	297 X 210 mm	Silver Landscape	2000-2200 W
	1250 mm	910 mm	210 X 297 mm	Silver Portrait	2000-2200 W
UFML00N0A3	1250 mm	910 mm	420 X 297 mm	Silver Landscape	2000-2200 W
	1310 mm	910 mm	297 X 420 mm	Silver Portrait	2000-2200 W
UFML10B0A4	fixed height	fixed height	297 X 210 mm	Black Landscape	2000-2200 W
	fixed height	fixed height	210 X 297 mm	Black Portrait	2000-2200 W
UFML10B0A3	fixed height	fixed height	420 X 297 mm	Black Landscape	2000-2200 W
	fixed height	fixed height	297 X 420 mm	Black Portrait	2000-2200 W

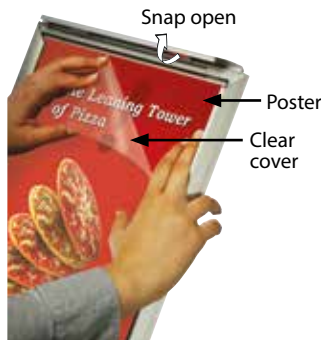

UFSL003300

UFSL002100

UFSL003100

UFSL002200

UFSL003200

Folder

MATERIAL : Silver anodised aluminium	
ARTICLE	CAPACITY
UDMB2002A4	2 X A4

MATERIAL: Acrylic

SHELF	DESCRIPTION	CAPACITY
UFSL002100	Steel shelf	2 X A5
UFSL003100	Acrylic shelf	2 X A5
UFSL002200	Steel shelf	1 X A4
UFSL003200	Acrylic shelf	1 X A4
UFSL003300	Acrylic shelf	1 X A4

Some possible Variations

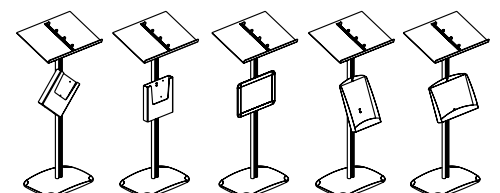

Classical

MATERIAL : Silver anodised aluminium

MITRED ARTICLE	ROUND ARTICLE	HEIGHT	POSTER	DESCRIPTION
UCMB1N05A4	UCMB1N00A4	1000 mm	297 X 210 mm	A4 Portrait
		964 mm	210 X 297 mm	A4 Landscape
UCMB1N05A3	UCMB1N00A3	1200 mm	420 X 297 mm	A3 Portrait
		1150 mm	297 X 420 mm	A3 Landscape



One product,
two positions
(landscape & portrait)



Decorative

MATERIAL : Silver anodised aluminium

MITRED ARTICLE	ROUND ARTICLE	HEIGHT	POSTER	DESCRIPTION
UDMB1N05A4	UDMB1N00A4	1000 mm	297 X 210 mm	A4 Portrait
		964 mm	210 X 297 mm	A4 Landscape
UDMB1N05A3	UDMB1N00A3	1200 mm	420 X 297 mm	A3 Portrait
		1150 mm	297 X 420 mm	A3 Landscape



Curved with Acryled

MATERIAL : Silver anodised aluminium & Black aluminium

SILVER	BLACK	HEIGHT	POSTER	DESCRIPTION
UCUALN00A4	UCUALB00A4	1250 mm	297 X 210 mm	A4 Portrait
		1215 mm	210 X 297 mm	A4 Landscape
UCUALN00A3	UCUALB00A3	1250 mm	420 X 297 mm	A3 Portrait
		1303 mm	297 X 420 mm	A3 Landscape

Curved

MATERIAL : Silver anodised aluminium & Black aluminium

SILVER MITRED	SILVER ROUND	BLACK MITRED	POSTER	HEIGHT	DESCRIPTION
UCUMBN05A4	UCUMBN00A4	UCUMBB05A4	210 X 297 mm	1212 mm	A4 Portrait
			1176 mm	A4 Landscape	
UCUMBN05A3	UCUMBN00A3	UCUMBB05A3	297 X 420 mm	1262 mm	A3 Portrait
			1212 mm	A3 Landscape	





SHELF

ARTICLE	CAPACITY	DESCRIPTION
UFSL002100	2 X A5	Steel shelf
UFSL003100	2 X A5	Acrylic shelf
UFSL002200	1 X A4	Steel shelf
UFSL003200	1 X A4	Acrylic shelf
UFSL003300	1 X A4	Acrylic shelf



UFSL002100

UFSL003100

UFSL002200

UFSL003200

UFSL003300

Adjustable

MATERIAL : Silver anodised aluminium

MITRED ARTICLE	ROUND ARTICLE	POSTER
UDMB1005A4	UDMB1000A4	210 X 297 mm
UDMB1005A3	UDMB1000A3	297 X 420 mm

Some possible variations

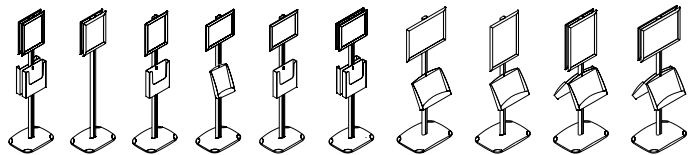

MATERIAL : Black & Black hammered powder coated

ARTICLE	CAPACITY	DESCRIPTION	HEIGHT
UMB00B04A4	4 X A4	Black	1270 mm / Portrait
UMB00N04A4	4 X A4	Hammered Black	1205 mm / Landscape

MATERIAL : Black & Black hammered powder coated

ARTICLE	CAPACITY	DESCRIPTION
UMB00B03A4	3 X A4	Black
UMB00N03A4	3 X A4	Hammered Black



Color options :
Black & hammered black.



Magnetic buttons
UYUP397000



Powder coated base
11,00 kg

Powder coated base
9,00 kg

3 X A4 Black

4 X A4 Black Hammered

Produced with durable steel material to suit outdoor conditions, Restaurant board is ideal for displaying menus, special offers, events and more. Steel base is covered with soft material to protect the floors. Textured black or Black-Grey finish is available. Message can be changed easily and captures the customer's attention in all frequented traffic areas.

RESTAURANT BOARDS

Our new stylish Curved free standing message board captures the customer's attention in all frequented traffic areas.

UNIVERSAL SHOWBOARD ON CURVED POST

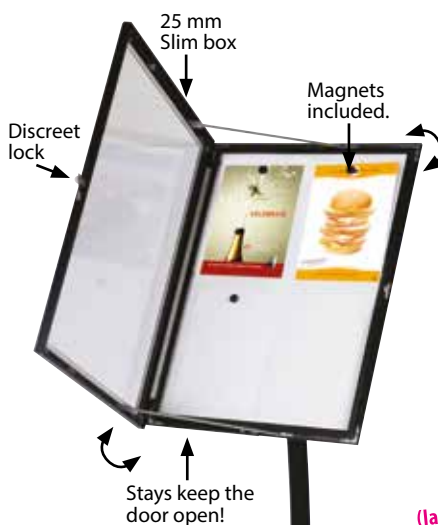

25 mm Slim box

Magnets included.

Discreet lock

Stays keep the door open!

One product, two positions (landscape & portrait)

MATERIAL: Black aluminium

ARTICLE	CAPACITY	DESCRIPTION
UCUS2B0481	4 X A4	Cork
UCUS3B0481	4 X A4	Magnetic

Heavy base, RAL 9005 powder coated 8,00 kg



The aluminium A Boards are durable and stable pavement signs, that holds printed poster, menus and deals and helps to get noticed in various environments. This outdoor sign has an easy to use snap open, front loading profiles which allows for a quick change of the poster. We offer different profiles with different corner finishings; Mitred, round and safe. It is ready for use as requires no tool assembly.

A BOARDS

Profile Type

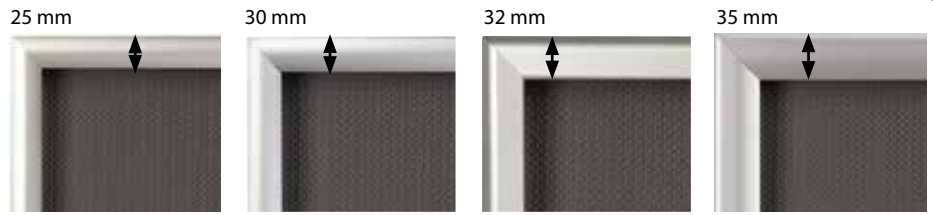

Corner Types



Mitred corner

Round corner

Safe corner

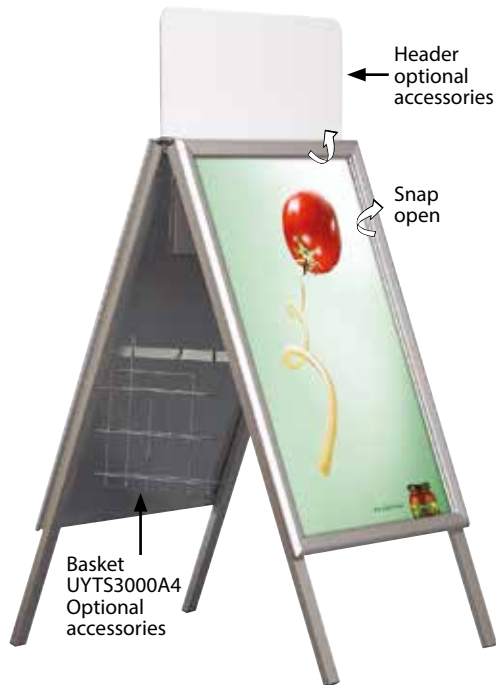

HEADER: 4 mm Plastech PVC Foam

ARTICLE	F1	F2
UYFT0000A2	460 mm	382 mm
UYFT0000A1	640 mm	562 mm
UYFT0000A1	640 mm	562 mm
UYFT0000A0	890 mm	812 mm
UYFT0000B2	540 mm	462 mm
UYFT0000B1	740 mm	662 mm
UYFT000023	548 mm	470 mm
UYFT000034	802 mm	724 mm

HEADER HOLDER

ARTICLE	X
UYTT0000A2	405 mm
UYTT0000A1	579 mm
UYTT0000A1	579 mm
UYTT0000A0	826 mm
UYTT0000B2	485 mm
UYTT0000B1	685 mm
UYTT000023	493 mm
UYTT000034	747 mm

Header

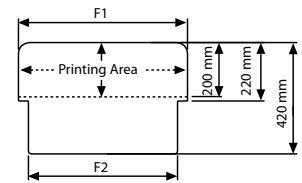

Header Holder

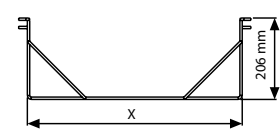

A Board

MATERIAL : Silver anodised aluminium PROFILE : 32 mm profile

MITRED ARTICLE	ROUND ARTICLE	SAFE CORNER	POSTER
UAB3250NA2	UAB3200NA2	UAB3210NA2	420 X 594 mm
UAB3250NA1	UAB3200NA1	UAB3210NA1	594 X 841 mm
UAB3251NA1	UAB3201NA1	UAB3211NA1	594 X 841 mm
UAB3250NA0	UAB3200NA0	UAB3210NA0	841 X 1189 mm
UAB3250NB2	UAB3200NB2	UAB3210NB2	500 X 700 mm
UAB3250NB1	UAB3200NB1	UAB3210NB1	700 X 1000 mm
UAB3250N23	UAB3200N23	UAB3210N23	508 X 762 mm
UAB3250N34	UAB3200N34	UAB3210N34	762 X 1016 mm



Eco

MATERIAL : Silver anodised aluminium

32 mm MITRED	32 mm ROUND	SAFE CORNER	25 mm MITRED	25 mm ROUND	POSTER
UAB325HNA1	UAB320HNA1	UAB321HNA1	UAB255HNA1	UAB250HNA1	594 X 841 mm
UAB325HNB2	UAB320HNB2	UAB321HNB2	UAB255HNB2	UAB250HNB2	500 X 700 mm
UAB325HNB1	UAB320HNB1	UAB321HNB1	UAB255HNB1	UAB250HNB1	700 X 1000 mm



Also see with safe corner

Weatherproof

MATERIAL : Silver anodised aluminium

ARTICLE	POSTER
UAB3550NA2	420 X 594 mm
UAB3550NA1	594 X 841 mm
UAB3550NB2	500 X 700 mm
UAB3550NB1	700 X 1000 mm

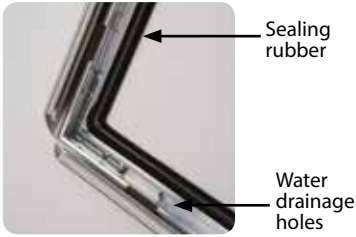

Opti Frame

MATERIAL : Silver anodised aluminium

32 mm MITRED	32 mm ROUND	25mm MITRED	25 mm ROUND	POSTER
UOAB325NA1	UOAB320NA1	UOAB255NA1	UOAB250NA1	594 X 841 mm
-	-	UOAB255NA2	UOAB250NA2	420 X 594 mm
UOAB325NB2	UOAB320NB2	UOAB255NB2	UOAB250NB2	500 X 700 mm

Opti®
Frame
A Board



Write On

MATERIAL : Silver anodised aluminium

ARTICLE	POSTER	DESCRIPTION
UWABONWOF1	600 X 800 mm	Silver-White
UWABONBOF1	600 X 800 mm	Silver-Black
UWABOBWOF1	600 X 800 mm	Black-White
UWABOBBOF1	600 X 800 mm	Black-Black



Wood Look

MATERIAL : Aluminium

ARTICLE	COPY AREA	DESCRIPTION
UAWL0000F1	600 X 800 mm	without header
UAWL1000F1	600 X 800 mm	with decorative header

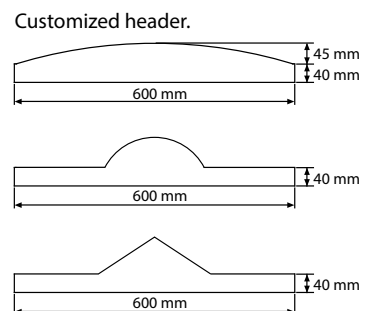

Don't forget to order
Chalkboard Marker
UYAKLM1251 - Colour Marker
UYAKLM1250 - White Marker



Writing area
is suitable for
chalkboard marker

Premium with Logo

MATERIAL : Silver anodised aluminium

ARTICLE	POSTER	HEADER PRINTING
UAPO305NA0	841 X 1189 mm	884 X 150 mm
UAPO305NA1	594 X 841 mm	637 X 150 mm
UAPO305NA2	420 X 594 mm	463 X 150 mm
UAPO305NB1	700 X 1000 mm	743 X 150 mm
UAPO305NB2	500 X 700 mm	543 X 150 mm
UAPO305N23	508 X 762 mm	551 X 150 mm
UAPO305N34	762 X 1016 mm	805 X 150 mm



Premium with Profile Logo

MATERIAL : Silver anodised aluminium

ARTICLE	POSTER	HEADER PRINTING
UAP1305NA0	841 X 1189 mm	841 X 120 mm
UAP1305NA1	594 X 841 mm	594 X 120 mm
UAP1305NA2	420 X 594 mm	420 X 120 mm
UAP1305NB1	700 X 1000 mm	700 X 120 mm
UAP1305NB2	500 X 700 mm	500 X 120 mm
UAP1305N23	508 X 762 mm	508 X 120 mm
UAP1305N34	762 X 1016 mm	762 X 120 mm



Easy Go

MATERIAL : Silver anodised aluminium

ARTICLE	POSTER
UABEGOONA1	594 X 841 mm
UABEGOONB2	500 X 700 mm
UABEGOONB1	700 X 1000 mm
UABEGOON22	559 X 711 mm
UABEGOON24	610 X 914 mm

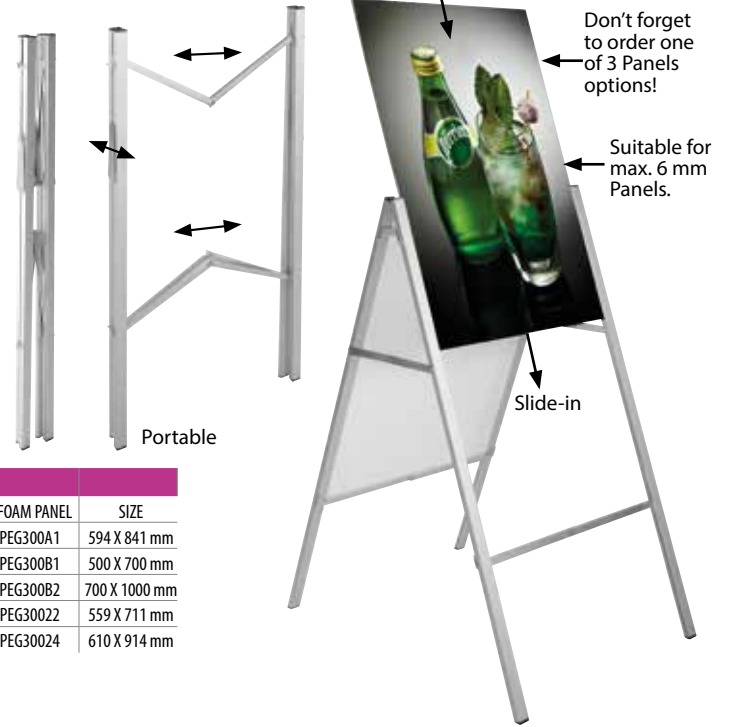

PANELS

CHALK PANEL	WRITE-ON PANEL	PVC FOAM PANEL	SIZE
UYPEG100A1	UYPEG200A1	UYPEG300A1	594 X 841 mm
UYPEG100B1	UYPEG200B1	UYPEG300B1	500 X 700 mm
UYPEG100B2	UYPEG200B2	UYPEG300B2	700 X 1000 mm
UYPEG10022	UYPEG20022	UYPEG30022	559 X 711 mm
UYPEG10024	UYPEG20024	UYPEG30024	610 X 914 mm

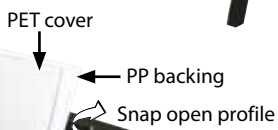

Slide-in

MATERIAL : Powder coated aluminium

GRAY	BLACK	POSTER
UABSON00A1	UABSOB00A1	594 X 841 mm
UABSON00B1	UABSOB00B1	700 X 1000 mm



Stainless Steel

MATERIAL : Steel

ARTICLE	POSTER SIZE	DESCRIPTION
USWAB00022	22" X 28" inch	Write - on A Board
USCAB00022	22" X 28" inch	Chalk A Board



Don't forget to order
Chalkboard Marker
UYAKLM1251 - Colour Marker
UYAKLM1250 - White Marker

A new stunning look for pavement signs, it consists of 2 main articles, one of which serves the frame while the other supports the base of the product. It is practical to change the poster. It can be easily loaded, has no sharp edges and has steel springs for flexibility. The spring connectors stabilize the position of your poster. The spring connectors stabilize the position of your poster. The spring connectors stabilize the position of your poster. The spring connectors stabilize the position of your poster.

PRO SERIES

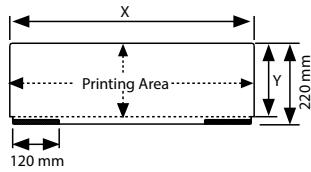

HEADER: 3 mm PVC Foam	
ARTICLE	PRINTING AREA (x-y)
UYFT0030A1	666 X 200 mm
UYFT0030A0	913 X 200 mm
UYFT0030B2	572 X 200 mm
UYFT0030B1	772 X 200 mm
UYFT003023	580 X 200 mm
UYFT003034	834 X 200 mm

One top goes with 2 different bases.

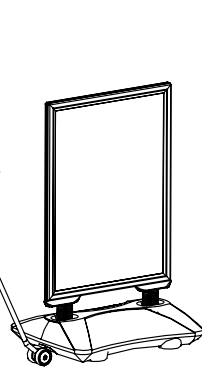

UYUP480945
Optional carry tool.
Pulling force 6-8 kg max.

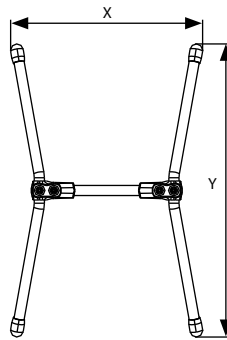

STEEL FEET			
GREY FEET	BLACK FEET	SIZE (x-y)	DESCRIPTION
UTSM001000	UTSM001010	690 X 920 mm	Small feet
UTSM002000	UTSM002010	690 X 1070 mm	Medium feet
UTSM003000	UTSM003010	890 X 1260 mm	Large feet
UTSM004000	UTSM004010	890 X 1420 mm	X large feet

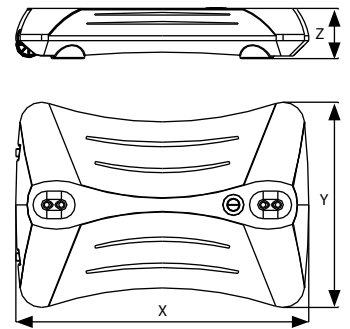

WATER BASE			
GREY BASE	BLACK BASE	SIZE (x-y-z)	DESCRIPTION
UTWM002000	UTWM002010	900 X 630 X 155 mm	Large base
UTWM001000	UTWM001010	720 X 580 X 155 mm	Small base

Snap open



Patent No: OHIM DM/084 128

Snap open



Patent No: OHIM DM/084 128

SwingPro®

STEEL BASE : Powder coated aluminium			
SILVER	BLACK	SIZE (x-y)	FOR
UTSM001000	UTSM001010	690 X 920 mm	20"X30" B2
UTSM002000	UTSM002010	690 X 1070 mm	A1
UTSM003000	UTSM003010	890 X 1260 mm	B1
UTSM004000	UTSM004010	890 X 1420 mm	A0

One top goes with 2 different bases.

FRAME : Silver anodised aluminium		
SILVER	BLACK	POSTER
USWP000NA1	USWP000BA1	594 X 841 mm
USWP000NA0	USWP000BA0	841 X 1189 mm
USWP000NB2	USWP000BB2	500 X 700 mm
USWP000NB1	USWP000BB1	700 X 1000 mm
USWP000N23	USWP000B23	508 X 762 mm
USWP000N34	USWP000B34	762 X 1016 mm

WindPro®

WATER BASE			
SILVER	BLACK	SIZE (x-y-z)	FOR
UTWM001000	UTWM001010	720 X 580 X 155 mm	20"X30" B2
UTWM002000	UTWM002010	900 X 630 X 155 mm	30"X40" B1
			A0

Illuminated WindPro With Led

MATERIAL : Silver & Black powder coated frame & waterbase

ARTICLE	POSTER
USWL000NA1	594 X 841 mm

Patent No: OHIM DM/084 128



UYPSWL0010
Spare battery



TZZZ998701
Cable lock kit for
WindPro 2100mm



Approx. weight is 40 kg when filled with water.



A Board
Maximum water capacity is 5 liter.



Provide lift of the sign



Pyramid
Maximum water capacity is 4,5 liter.

Stable, heavy and enduring pavement sign. Suitable to set aside in parking areas, play grounds, shop entrances and busy pavement roads; especially for windy areas. Standard in metallic RAL 9006 color. By opening the plastic stoppers, you can pour in either water or sand to make the stand heavier.

WATERBASE PAVEMENT SIGNS

MATERIAL: High density polyetilen

ARTICLE	MODEL	WEIGHT WITH WATER
UWPS005000	Pyramit	5,5 kg
UWPS001000	A Board	8 kg

Various Sizes are available all with Mitred corners. After the closure of the side profiles, the rubber seal inside the wind sign in addition with over Size PET makes the product waterproof. The easy-to-open snap frame includes an anti-reflex cover suitable for external use when equipped with a water wick. Product is double sided. The steel springs provide the flexibility to ensure stability. The wheels enable the movement of the units.

SWINGMASTER & WATERBASE WIND SIGN



Safe corner

Header optional accessories

Water tank

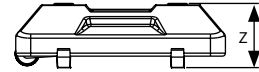
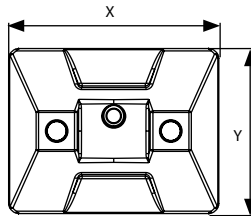
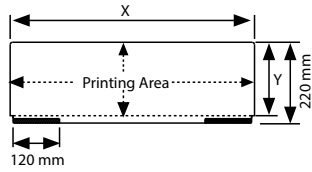

HEADER: 3 mm PVC Foam

ARTICLE	PRINTING AREA (x-y)
UYFT0010A2	492 X 200 mm
UYFT0010A1	666 X 200 mm
UYFT0010A0	913 X 200 mm
UYFT0010B2	572 X 200 mm
UYFT0010B1	772 X 200 mm
UYFT0010B0	1072 X 200 mm
UYFT001023	580 X 200 mm
UYFT001034	834 X 200 mm
UYFT001046	1088 X 200 mm

WIND SIGN BASE

ARTICLE	SIZE (x-y-z)	DESCRIPTION
UYUP406820	700 X 550 X 210 mm	Small base
UYUP406810	820 X 650 X 210 mm	Medium Base
UYUP406840	1000 X 750 X 210 mm	Large Base



UYUP480945
Optional carry tool.
Pulling force 6-8 kg max.



Eco Waterbase Wind Sign

MATERIAL : Silver anodised aluminium

ARTICLE	POSTER
UEWM000NA2	420 X 594 mm
UEWM000NA1	594 X 841 mm
UEWM000NA0	841 X 1189 mm
UEWM000NB2	500 X 700 mm
UEWM000NB1	700 X 1000 mm
UEWM000NB0	1000 X 1400 mm
UEWM000N23	508 X 762 mm
UEWM000N34	762 X 1016 mm
UEWM000N46	1016 X 1524 mm



Swingmaster

MATERIAL : Silver anodised aluminium

ARTICLE	POSTER
UASM000NA2	420 X 594 mm
UASM000NA1	594 X 841 mm
UASM000NA0	841 X 1189 mm
UASM000NB2	500 X 700 mm
UASM000NB1	700 X 1000 mm
UASM000NB0	1000 X 1400 mm
UASM000N23	508 X 762 mm
UASM000N34	762 X 1016 mm
UASM000N46	1016 X 1524 mm

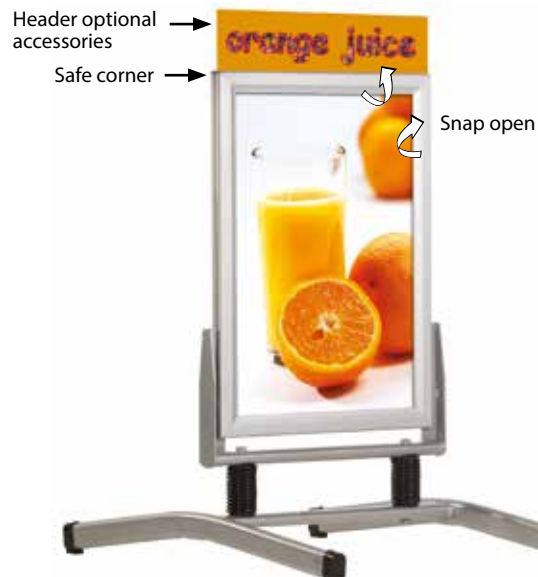

Eco Swingmaster

MATERIAL : Silver anodised aluminium

ARTICLE	POSTER
UESM000NA2	420 X 594 mm
UESM000NA1	594 X 841 mm
UESM000NA0	841 X 1189 mm
UESM000NB2	500 X 700 mm
UESM000NB1	700 X 1000 mm
UESM000NB0	1000 X 1400 mm
UESM000N23	508 X 762 mm
UESM000N34	762 X 1016 mm
UESM000N46	1016 X 1524 mm

FRAME : Silver anodised aluminium

SILVER	BLACK	POSTER
ISWPL00NA1W	ISWPL00BA1W	594 X 841 mm
ISWPL00NA0W	ISWPL00BA0W	841 X 1189 mm
ISWPL00NB1W	ISWPL00BB1W	700 X 1000 mm



new

WindPro Lite is heavy and robust waterbase pavement sign for outdoor. It consists of 2 main articles: frame and the base. No sharp edges and has steel springs for flexibility. Poster use is double sided.

WINDPRO LITE PAVEMENT SIGNS

FRAME : Silver anodised aluminium

SILVER	BLACK	POSTER
ISWPP00NA1W	ISWPP00BA1W	594 X 841 mm
ISWPP00NA0W	ISWPP00BA0W	841 X 1189 mm
ISWPP00NB1W	ISWPP00BB1W	700 X 1000 mm

With increased performance, WindPro Plus is more durable against outdoor conditions. It consists of 2 main articles: frame and the base. The gasket in frame provides high vacuuming to UV resistant poster protection to keep the poster dry. PET is fixed on the top profile to help easy poster change. The poster stickers are also keep the poster in place avoid sliding down the frame get wet. No sharp edges and has steel springs for flexibility. Poster use is double sided.

new

WINDPRO PLUS PAVEMENT SIGNS



Simple plastic pavement board for multiple purposes. PS Display has options for printing & lamination and chalk. Easy to move and store. Chalk option is suitable to write on with waterbase chalk pens.

PS BOARDS

Provide easy lift of the sign



Carry PS Board

PS Chalk Board

MATERIAL: Polystyrene			
ARTICLE	SIZE	PRINTING AREA	MODEL
UPYP000000	500 X 880 mm	480 X 815 mm	PS Board
UPYPE00000	500 X 880 mm	480 X 815 mm	Carry PS Board
UPYP001000	500 X 880 mm	480 X 815 mm	PS Chalk Board

Don't forget to order Chalkboard Marker
UYAKLM1251 - Colour Marker
UYAKLM1250 - White Marker



Ø 25 mm



Ø 21 mm

Stable & heavy pavement sign, used from both sides. There is a magnetic cover placed over the poster. Suitable for highly frequented public areas. Also available in black.

MAGNETIC IRON A BOARDS



Round

MATERIAL: Steel		
ARTICLE	POSTER	HEADER (x-y)
UABD255NA2	420 X 594 mm	420 X 240 mm
UABD255NA1	594 X 841 mm	594 X 327 mm
UABD255NB2	500 X 700 mm	500 X 280 mm
UABD255NB1	700 X 1000 mm	700 X 380 mm
UABD255N23	508 X 762 mm	508 X 284 mm
UABD255N34	762 X 1016 mm	762 X 411 mm

Rectangular

MATERIAL: Steel			
WITH HEADER	WITHOUT HEADER	POSTER	HEADER (x-y)
UABD211NA2	UABD210NA2	420 X 594 mm	450 X 175 mm
UABD211NA1	UABD210NA1	594 X 841 mm	624 X 175 mm
UABD211NB2	UABD210NB2	500 X 700 mm	530 X 175 mm
UABD211NB1	UABD210NB1	700 X 1000 mm	730 X 175 mm
UABD211N23	UABD210N23	508 X 762 mm	538 X 175 mm

Header

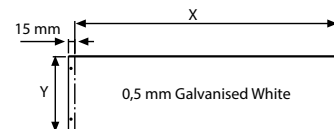

A double-sided pavement sign, constructed entirely from plastic.

SIGN BOY



MATERIAL: Polystyrene		
ARTICLE	SIZE	MATERIAL
SB	540 X 990	PS Board

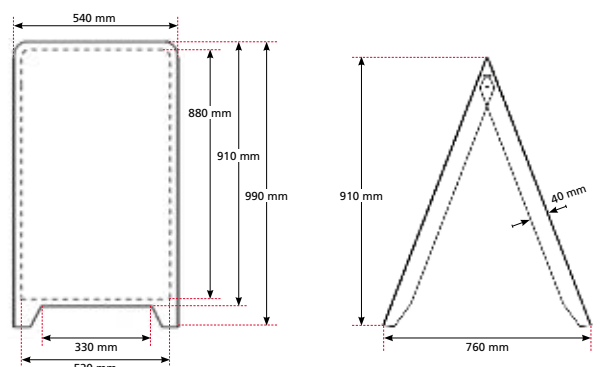

With their waterproof and fade resistant feature, Wood displays are suitable for outdoor use. Yet remarkably their surfaces can be easily cleared of materials such as glass and plastics. This helps you to change your messages or prices. Our standard pen sets are defined next with the colors inside.

WOOD DISPLAY

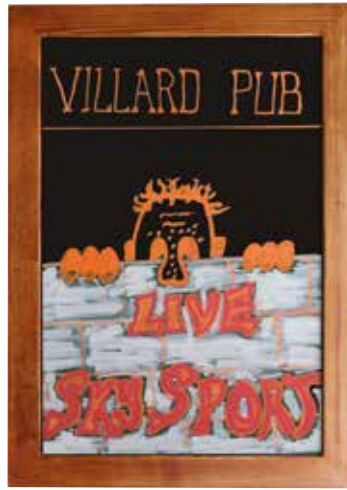

Single Sided Wooden Frame

MATERIAL: Wood		
ARTICLE	SIZE	DESCRIPTION
UWSS010034	300 X 400 mm	Black Chalkboard
UWSS010046	400 X 600 mm	Black Chalkboard
UWSS010049	400 X 900 mm	Black Chalkboard
UWSS010068	600 X 800 mm	Black Chalkboard
UWSS010061	600 X 1150 mm	Black Chalkboard
UWSS010081	800 X 1200 mm	Black Chalkboard



Don't forget to order Chalkboard Marker
UYAKLM1251 - Colour Marker
UYAKLM1250 - White Marker



Frameless Wooden Frame

MATERIAL: Wood		
ARTICLE	SIZE	DESCRIPTION
UWFF010034	300 X 400 mm	Black Chalkboard
UWFF010046	400 X 600 mm	Black Chalkboard
UWFF010049	400 X 900 mm	Black Chalkboard
UWFF010068	600 X 800 mm	Black Chalkboard
UWFF010061	600 X 1150 mm	Black Chalkboard
UWFF010081	800 X 1200 mm	Black Chalkboard



Black hinges



Wooden Stopper

MATERIAL: Wood		
ARTICLE	SIZE	DESCRIPTION
UWSR110068	600 X 800 mm	Black chalkboard, massive wood

Foldable



new

Solid wood



Wooden Host

MATERIAL: Wood		
ARTICLE	SIZE	DESCRIPTION
UWHT010068	600 X 800 mm	Black chalkboard, solid wood

Wood A Board Outdoor

MATERIAL: Wood		
ARTICLE	SIZE	DESCRIPTION
UWOD006078	600 X 780 mm	Black chalkboard, massive wood

Ultra Slim "SMART LEDBOX"

We offer single and double sided LED illuminated frames to use indoor or outdoor. You will have the choice for snap profiles or magnetic covers. All are complete with powersupplies and wall hanger or suspension kit. What ever you decide, they are ready to use. LED illuminated technology offers high illumination so that you attract people to your message.

LEDBOXES

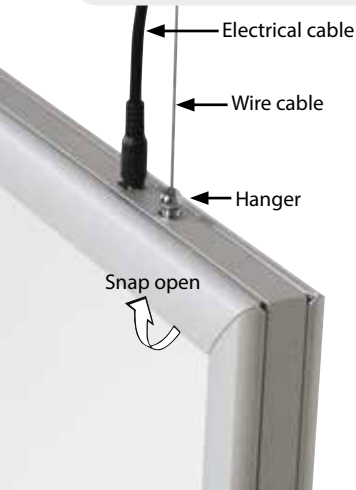

Profile Type

25 mm

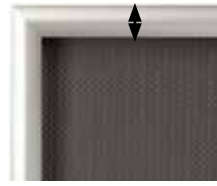

35 mm

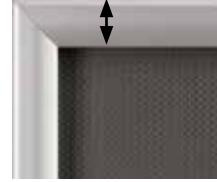

Model



Single sided



Double sided

Hanger



2 wall hangers are standard in each product. Moving hangers let the mounting in Portrait and Landscape position.



Standard hanging kit for all Sizes: 2 meters x 2 pcs wire cable and 2 ceiling hangers.

Dimmer



Optional dimmer to go with LED illuminated frame.. Simply jack the dimmer in frame and then into powersupply. It adjust the light from dark to max lux of LED illuminated frame.



- Improved Led technology for improved luminance.
- Pre-treated light guided Panel diffuses light even & powerful.
- CE & UL listed electrical components.
- Offers evenly diffused lux in all Sizes.
- Snap - open frame for easy poster change.
- Saves up to 60% from energy costs.

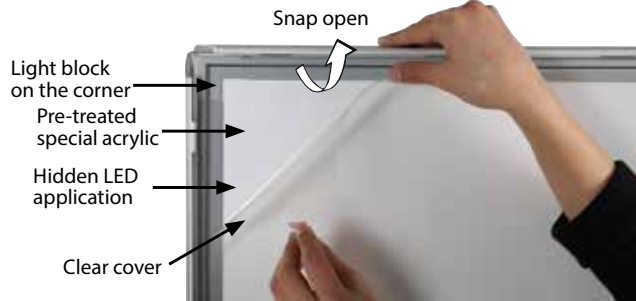

Very Slim, Magneco LEDbox is a new generation in LEDboxes. With a practical magnetic protection cover, it is very easy to change the poster. High and even illumination level attracts consumers to the message. Hidden finger hole to take off the acrylic cover prevents public access to the poster.

MAGNECO LEDBOX

13 mm Single Sided

MATERIAL: Silver & Black anodised aluminium

SILVER	BLACK	POSTER
ULDMEN0BA4	ULDMEB0BA4	210 X 297 mm
ULDMEN0BA3	ULDMEB0BA3	297 X 420 mm
ULDMEN0BA2	ULDMEB0BA2	420 X 594 mm
ULDMEN0BA1	ULDMEB0BA1	594 X 841 mm
ULDMEN0BA0	ULDMEB0BA0	841 X 1189 mm
ULDMEN0BB2	ULDMEB0BB2	500 X 700 mm
ULDMEN0BB1	ULDMEB0BB1	700 X 1000 mm



13 mm frame



new

18 mm snap frame



18 mm Single Sided

MATERIAL: Silver anodised aluminium

SILVER	POSTER
ULB25ST0A4	210 X 297 mm
ULB25ST0A3	297 X 420 mm
ULB25ST0A2	420 X 594 mm
ULB25ST0A1	594 X 841 mm
ULB25ST0A0	841 X 1189 mm
ULB25ST0B2	500 X 700 mm
ULB25ST0B1	700 X 1000 mm
ULB25ST023	20 X 30 "
ULB25ST034	30 X 40 "

Very slim single sided Best Buy LEDbox with 18 mm thickness is an ideal choice for a wide range of indoor applications. High illumination is achieved by specially treated acrylic and provides a homogenous illumination. Homogenous and brilliant Best Buy LEDbox will get the attention of consumers easily wherever it is mounted.

BEST BUY LEDBOX

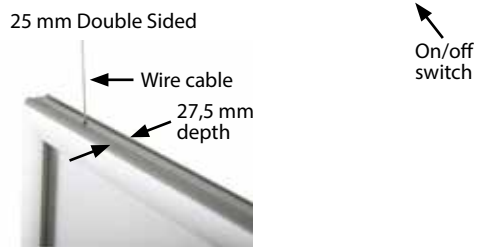
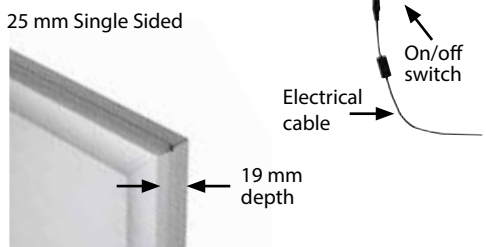

25 mm Single Sided

MATERIAL : Silver anodised aluminium

ARTICLE	POSTER	LIGHTING
ULD25TNOA4	210 X 297 mm	1700-2000 LUX
ULD25TNOA3	297 X 420 mm	3300-3600 LUX
ULD25TNOA2	420 X 594 mm	3000-3300 LUX
ULD25TNOA1	594 X 841 mm	2700-3000 LUX
ULD25TNOB2	500 X 700 mm	2900-3200 LUX
ULD25TNOB1	700 X 1000 mm	2500-2800 LUX
ULD25TNO23	508 X 762 mm	2900-3200 LUX
ULD25TNO34	762 X 1016 mm	2500-2800 LUX

25 mm Double Sided

MATERIAL : Silver anodised aluminium

ARTICLE	POSTER	LIGHTING
ULD25CNOA4	210 X 297 mm	1500-1800 LUX
ULD25CNOA3	297 X 420 mm	2000-2300 LUX
ULD25CNOA2	420 X 594 mm	1800-2000 LUX
ULD25CNOA1	594 X 841 mm	1600-1800 LUX
ULD25CNOB2	500 X 700 mm	1700-1900 LUX
ULD25CNO23	508 X 762 mm	1700-1900 LUX

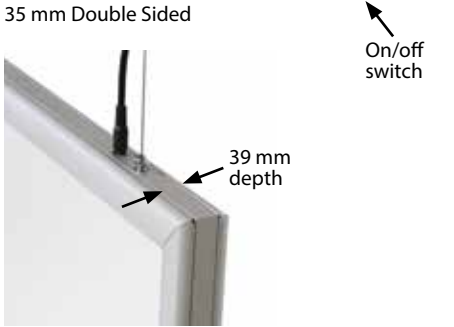
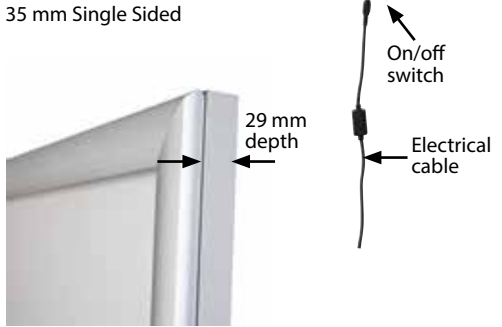
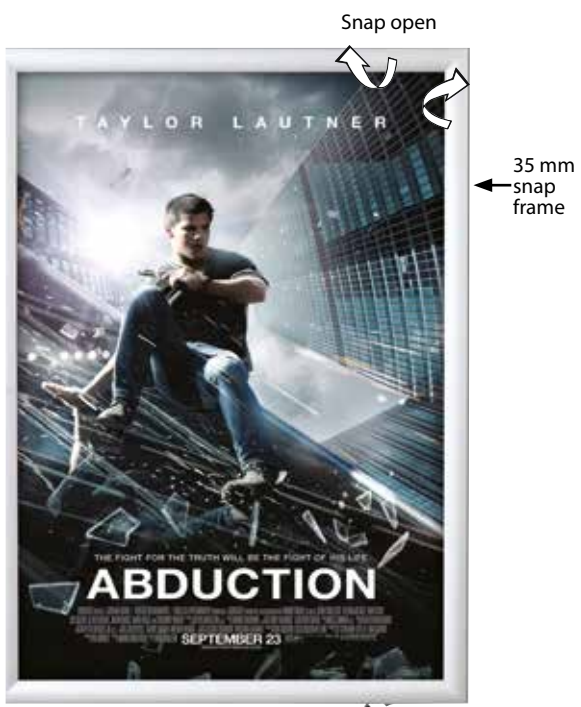

35 mm Single Sided

MATERIAL : Silver anodised aluminium

ARTICLE	POSTER	LIGHTING
ULD35TNOA4	210 X 297 mm	4200-4500 LUX
ULD35TNOA3	297 X 420 mm	3900-4200 LUX
ULD35TNOA2	420 X 594 mm	3500-3900 LUX
ULD35TNOA1	594 X 841 mm	3000-3300 LUX
ULD35TNOA0	841 X 1189 mm	2500-2800 LUX
ULD35TNOB2	500 X 700 mm	3000-3300 LUX
ULD35TNOB1	700 X 1000 mm	2600-2900 LUX
ULD35TNOB0	1000 X 1400 mm	2000-2300 LUX
ULD35TNO23	508 X 762 mm	3000-3300 LUX
ULD35TNO34	762 X 1016 mm	2600-2900 LUX
ULD35TNO46	1016 X 1524 mm	2000-2300 LUX

35 mm Double Sided

MATERIAL : Silver anodised aluminium

ARTICLE	POSTER	LIGHTING
ULD35CNOA1	594 X 841 mm	2100-2400 LUX
ULD35CNOA0	841 X 1189 mm	1800-2100 LUX
ULD35CNOB1	700 X 1000 mm	2000-2300 LUX
ULD35CNOB0	1000 X 1400 mm	1500-1800 LUX
ULD35CNO34	762 X 1016 mm	2000-2300 LUX
ULD35CNO46	1016 X 1524 mm	1500-1800 LUX

Weatherproof Power Supply (IP67)

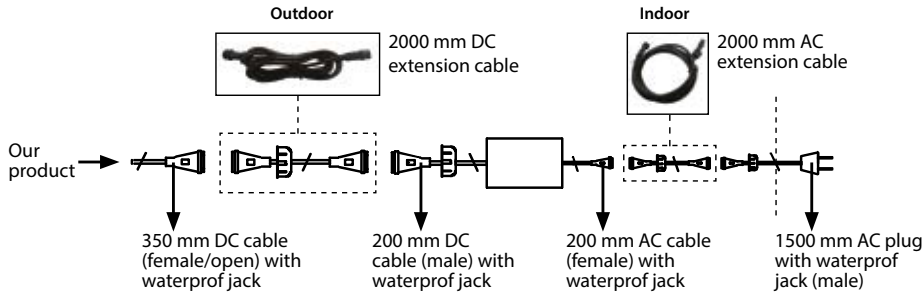

Mobile cable outlet, from the edge and from the back of the aluminum box.

- Improved Led technology and laser treatment.
- IP67 and CE listed electrical components.
- Offers evenly diffused lux in all Sizes.



Weatherproof, 35 mm Single Sided

MATERIAL : Silver anodised aluminium

ARTICLE	POSTER	LIGHTING
ULS35TN0A4	210 X 297 mm	2600-2900 LUX
ULS35TN0A3	297 X 420 mm	2700-3000 LUX
ULS35TN0A2	420 X 594 mm	1800-2100 LUX
ULS35TN0A1	594 X 841 mm	1600-1900 LUX
ULS35TN0A0	841 X 1189 mm	1200-1500 LUX
ULS35TN0B2	500 X 700 mm	1600-1900 LUX
ULS35TN0B1	700 X 1000 mm	1400-1700 LUX
ULS35TN0B0	1000 X 1400 mm	1000-1200 LUX
ULS35TN023	508 X 762 mm	1600-1900 LUX
ULS35TN034	762 X 1016 mm	1400-1700 LUX
ULS35TN046	1016 X 1524 mm	1000-1200 LUX



Lockable Weatherproof, 35 mm, Single Sided

MATERIAL : Silver anodised aluminium

ARTICLE	POSTER SIZE	LIGHTING
ULH35TN0A4	210 X 297 mm	2600-2900 LUX
ULH35TN0A3	297 X 420 mm	2700-3000 LUX
ULH35TN0A2	420 X 594 mm	1800-2100 LUX
ULH35TN0A1	594 X 841 mm	1600-1900 LUX
ULH35TN0A0	841 X 1189 mm	1200-1500 LUX
ULH35TN0B2	500 X 700 mm	1600-1900 LUX
ULH35TN0B1	700 X 1000 mm	1400-1700 LUX
ULH35TN0B0	1000 X 1400 mm	1000-1200 LUX
ULH35TN023	508 X 762 mm	1600-1900 LUX
ULH35TN034	762 X 1016 mm	1400-1700 LUX
ULH35TN046	1016 X 1524 mm	1000-1200 LUX

Ideal Ledbox 25 mm Single Sided

MATERIAL : Silver anodised aluminium

ARTICLE	POSTER SIZE	LIGHTING
ULE25TN0A4	210 X 297 mm	3000-3300 LUX
ULE25TN0A3	297 X 420 mm	2600-2900 LUX
ULE25TN0A2	420 X 594 mm	2300-2600 LUX
ULE25TN0A1	594 X 841 mm	1700-1900 LUX
ULE25TN0A0	841 X 1189 mm	1300-1600 LUX
ULE25TN0B2	500 X 700 mm	2000-2300 LUX
ULE25TN0B1	700 X 1000 mm	1600-1800 LUX

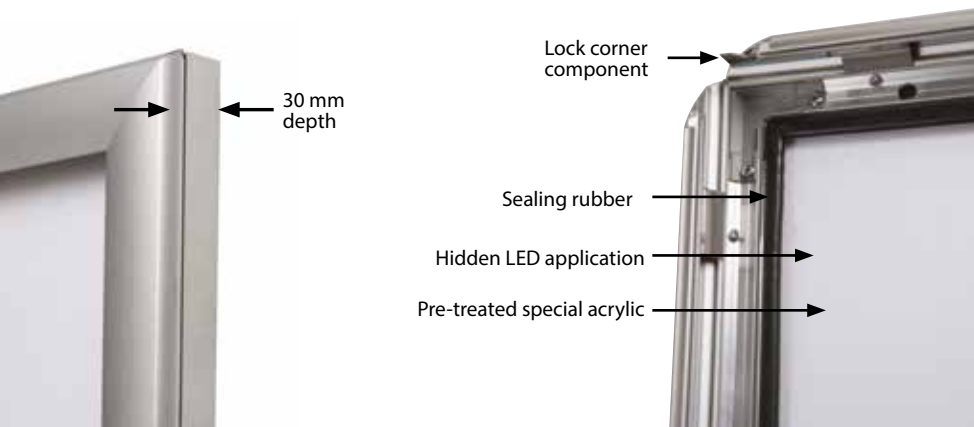

Single faced convex boxes are available in various Sizes. Accesso poster is by snap frame profiles on each long side which are in 25mm. The surface is opal acrylic. Convex Lightbox includes a PET cover which is ideal to illuminate your duratrans & poster without reflection. For best results, use printings on backlit film or duratrans.

CONVEX LEDBOX

MATERIAL : Silver anodised aluminium

ARTICLE	POSTER
UCLB25LNA4	210 X 297 mm
UCLB25LNA3	297 X 420 mm
UCLB25LNA2	420 X 594 mm
UCLB25LNA1	594 X 841 mm
UCLB25LNB2	500 X 700 mm
UCLB25LNB3	508 X 762 mm



28 mm depth



Magnetic Smart LEDbox: A new generation in LEDboxes. With a practical magnetic protection cover, it is very easy to change the poster. High illumination level attracts consumers to the message.

MAGNETIC SMART LEDBOX

MATERIAL : Silver anodised aluminium

ARTICLE	POSTER	LIGHTING
ULDMON00A4	210 X 297 mm	5500-6000 LUX
ULDMON00A3	297 X 420 mm	5000-5400 LUX
ULDMON00A2	420 X 594 mm	4600-4900 LUX
ULDMON00A1	594 X 841 mm	3500-3800 LUX
ULDMON00A0	841 X 1189 mm	2800-3200 LUX
ULDMON00B2	500 X 700 mm	4000-4300 LUX
ULDMON00B1	700 X 1000 mm	3000-3300 LUX

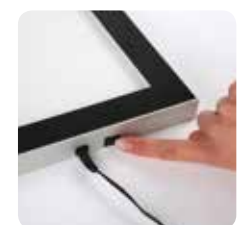
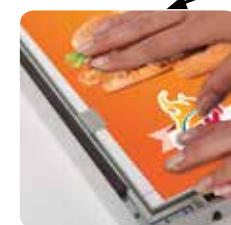
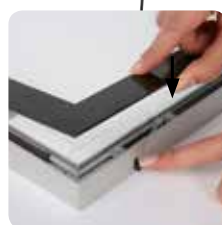

Open magnetic clear cover

Slide-in poster

On/off switch

Modular alphabet with LED

The sockets to be used to collocate the letters are specially designed as Silver plated brass. Therefore it is resistant to corrosion and the relevant problems. The most important feature of modular letters is that LEDs' high lumen output with their 90.000 hrs lifetime. Injection moulded letters are UV filtered and their colour will not fade away in case of direct sunlight exposure. Their printed circuit boards are double sided and epoxide. The modular letters are impact modified and riveting method is used to prevent copper strips from being broken off. Products are for indoor use.

SMART LED LETTER



- Practical Application
- Environmentalist solution
- Affordable
- LED Integration
- Highly Productive
- Very Noticeable



Individual packing

MATERIAL : Injected plastic

ARTICLE	LETTER	WIDTH	HEIGHT	THICKNESS
Ulldorc001	A	112 mm	116 mm	14 mm
Ulldorc002	B	94 mm	116 mm	14 mm
Ulldorc003	C	102 mm	118 mm	14 mm
Ulldorc005	D	100 mm	116 mm	14 mm
Ulldorc006	E	87 mm	116 mm	14 mm
Ulldorc007	F	87 mm	116 mm	14 mm
Ulldorc008	G	112 mm	116 mm	14 mm
Ulldorc010	H	97 mm	116 mm	14 mm
Ulldorc011	I	42 mm	116 mm	14 mm
Ulldorc013	J	47 mm	110 mm	14 mm
Ulldorc014	K	100 mm	116 mm	14 mm
Ulldorc015	L	83 mm	116 mm	14 mm
Ulldorc016	M	115 mm	116 mm	14 mm
Ulldorc017	N	98 mm	116 mm	14 mm
Ulldorc018	O	118 mm	118 mm	14 mm
Ulldorc020	P	95 mm	116 mm	14 mm
Ulldorc021	R	109 mm	116 mm	14 mm
Ulldorc022	S	103 mm	116 mm	14 mm
Ulldorc024	T	97 mm	116 mm	14 mm
Ulldorc025	U	105 mm	118 mm	14 mm
Ulldorc027	V	109 mm	120 mm	14 mm
Ulldorc028	Y	103 mm	120 mm	14 mm
Ulldorc029	Z	95 mm	115 mm	14 mm
Ulldorc030	Q	118 mm	118 mm	14 mm
Ulldorc031	W	130 mm	120 mm	14 mm
Ulldorc032	X	100 mm	116 mm	14 mm
Ulldorc033	SPACE	87 mm	26 mm	14 mm
Ulldorc034	&	130 mm	110 mm	14 mm
Ulldorn000	0	105 mm	116 mm	14 mm
Ulldorn001	1	80 mm	116 mm	14 mm
Ulldorn002	2	100 mm	116 mm	14 mm
Ulldorn003	3	100 mm	116 mm	14 mm
Ulldorn004	4	115 mm	116 mm	14 mm
Ulldorn005	5	105 mm	116 mm	14 mm
Ulldorn006	6	100 mm	116 mm	14 mm
Ulldorn007	7	95 mm	116 mm	14 mm
Ulldorn008	8	105 mm	116 mm	14 mm
Ulldorn009	9	105 mm	116 mm	14 mm
Ulldorf000	BLINKER	65 mm	26 mm	14 mm
Ulldort000	ENDCAP	3 mm	22 mm	14 mm
Ulldlar1020	ADAPTOR	-	-	-

Letters

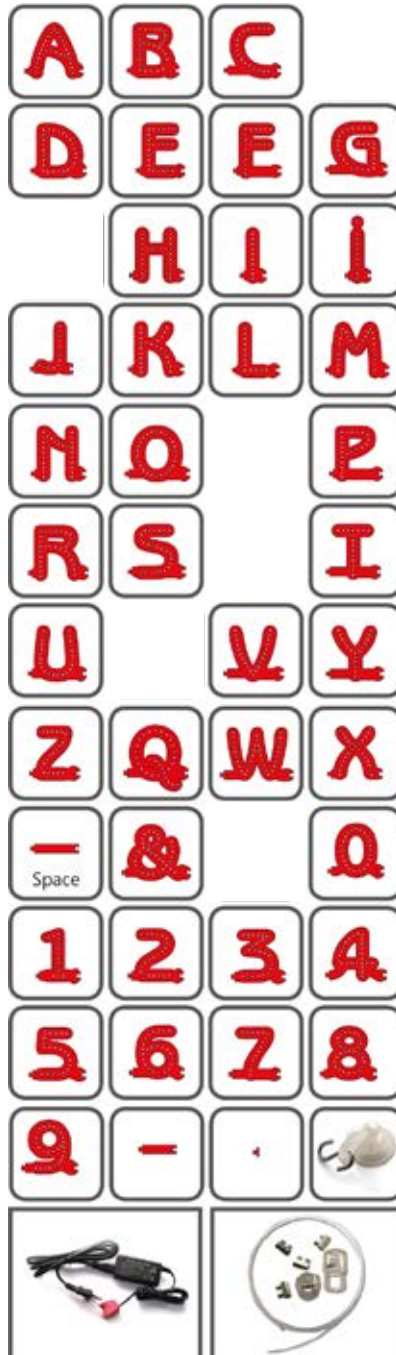

Standard word combinations

PHARMACY CASH
 TAKEAWAY PIZZA
 UNISEX NAIL BAR
 OPEN 24 HR TAXI
 MARKET ENTRANCE
 CAR PARK CLOSED
 MASSAGE BURGERS
 BARBER SHOP EXIT
 FISH&CHIPS OPEN
 KIDS CLUB CAFE



Presentation Kit / UYUP480400



Ultra slim and clear Acryled. The edge-lit mounts portrait or landscape for various types of signage. Edge-lit Acryled lights up poster in sizes of A4, A3, A2. Acryled lit with LEDs use less power than traditional illuminated signage. poster is placed in between the specially treated acrylic & cover acrylic sheet & fixed in position by two clear clips on two short sides. Products are available in 2 colours; silver and black. Compared to traditional articles in the market, Acryled provides easy poster change when unit keeps mounted on the wall.

ACRYLED FOR WALL MOUNTING



MATERIAL : Treated illuminated acrylic		
ARTICLE	POSTER	DESCRIPTION
UACLON00A4	210 X 297 mm	Square - Silver
UACLON00A3	297 X 420 mm	Square - Silver
UACLON00A2	420 X 594 mm	Square - Silver
UACLON00A1	594 X 841 mm	Square - Silver
UACLOB00A4	210 X 297 mm	Square - Black
UACLOB00A3	297 X 420 mm	Square - Black
UACLOB00A2	420 X 594 mm	Square - Black
UACLOB00A1	594 X 841 mm	Square - Black
UACLYN0000	Ø 446	Circle - Silver
UACLYB0000	Ø 446	Circle - Black
UACLEN0000	700 X 350 mm	Eliptical - Silver
UACLEB0000	700 X 350 mm	Eliptical - Black



Mono with light

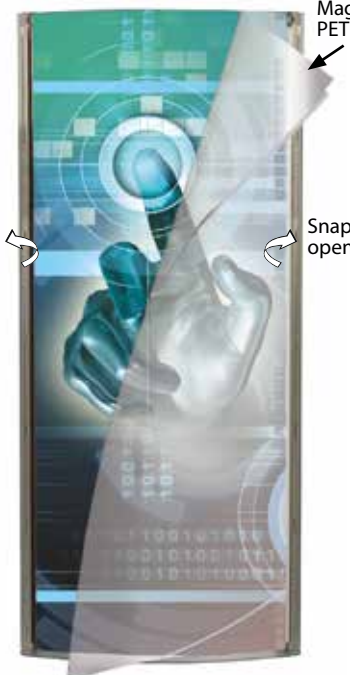

Magnetic PET cover

Snap open

Snap open



Decorative Panel

We offer illuminated or non illuminated Totems. You can select any styles we offer you or customise your own Totem with decorative one. Choose the best for you.

TOTEMS

CE & UL approved.



Pegs to hold poster

Snap open

Magnetic PET cover

Mono

MATERIAL: Silver anodised aluminium

ARTICLE	POSTER	DESCRIPTION
UTTME10500	500 X 1700 mm	without light
UTTME10600	600 X 1700 mm	without light
UTTME00500	500 X 1700 mm	with light
UTTME00600	600 X 1700 mm	with light

Totem

MATERIAL: Silver anodised aluminium

ARTICLE	POSTER	LIGHTING
UTTM001000	600 X 1700 mm	1 X 58 W
UTTM002000	700 X 1700 mm	1 X 58 W
UTTM003000	800 X 1700 mm	2 X 58 W

Decorative

MATERIAL: Silver anodised aluminium

ARTICLE	POSTER	LIGHTING
UTTM011010	594 X 841 mm	1 X 18 W
UTTM011020	700 X 1000 mm	1 X 30 W
UTTM011040	500 X 700 mm	1 X 18 W
UTTM011030	841 X 1189 mm	2 X 36 W

Slim and Sleek!

The lockable poster Display case, Universal Showboard is designed to display printed poster in different options. When seen on the wall, it looks like a snap frame with slim case which is 27 mm deep, 30 mm profile and hidden lock on the side. It is suitable for public places or outdoor use under a shelter. It is easier to change the poster with hinged door and clips holding the poster.

27 mm thickness



Universal Poster

MATERIAL: Silver anodised aluminium		
ARTICLE	POSTER SIZE	KEY
USBNU000A4	210 X 297 mm	1
USBNU000A3	297 X 420 mm	1
USBNU000A2	420 X 594 mm	1
USBNU000A1	594 X 841 mm	2
USBNU000A0	841 X 1189 mm	2
USBNU000B2	500 X 700 mm	1
USBNU000B1	700 X 1000 mm	1
USBNU00023	508 X 762 mm	1
USBNU00034	762 X 1016 mm	2



Clear plastic pegs hold the poster



Handles keep the door open



Discreet door lock! One set of 2 key included in the pack!

UNIVERSAL SHOWBOARDS



M&C



Cork

Magnetic



Chalkboard Marker
UYKLM1251 - Colour Marker
UYKLM1250 - White Marker

Frameboard

MATERIAL: Silver anodised aluminium			
CORK	MAGNETIC	M&C	CAPACITY
U1CB95N144	U2CB95N144	U3CB95N144	4 X A4
U1CB95N164	U2CB95N164	U3CB95N164	6 X A4
U1CB95N194	U2CB95N194	U3CB95N194	9 X A4
U1CB95N114	U2CB95N114	U3CB95N114	12 X A4



Cork Board

MATERIAL: Silver anodised aluminium	
ARTICLE	CAPACITY
UCBON004A4	4 X A4
UCBON006A4	6 X A4
UCBON009A4	9 X A4



2xV hangers in each box.

Suitable for outdoor use. It has 4 models; with a poster, with a cork backing, with a magnetic backing, with a cork and perforated steel backing. Can be used both in portrait & landscape positions. The cover can be opened to 90 degrees. Each unit includes mounting screw and plugs for easy wall mounting and a free set of pins & magnets. The profile width is 45 mm and the depth of the case 30 mm.

SHOWBOARDS



Discreet door lock!



Clear plastic pegs hold the poster

30 mm thickness

Poster

MATERIAL: Silver anodised aluminium		
ARTICLE	POSTER	KEY
USBNU000A3	297 X 420 mm	1
USBNU000A2	420 X 594 mm	1
USBNU000A1	594 X 841 mm	2
USBNU000A0	841 X 1189 mm	2
USBNU000B2	500 X 700 mm	1
USBNU000B1	700 X 1000 mm	2
USBNU00023	508 X 762 mm	1
USBNU00034	762 X 1016 mm	2





One set of 2 key included in the pack!

36 mm thickness

Cork - Magnetic - M&C

MATERIAL: Silver anodised aluminium				
CORK	MAGNETIC	M&C	CAPACITY	KEY
USBN1004A4	USBN2004A4	USBN3004A4	4 X A4	1
USBN1006A4	USBN2006A4	USBN3006A4	6 X A4	2
USBN1009A4	USBN2009A4	USBN3009A4	9 X A4	2
USBN1012A4	USBN2012A4	USBN3012A4	12 X A4	2

Felt

MATERIAL: Silver anodised aluminium					
RED	BLUE	GRAY	GREEN	CAPACITY	KEY
USBN1104A4	USBN1204A4	USBN1404A4	USBN1304A4	4 X A4	1
USBN1106A4	USBN1206A4	USBN1406A4	USBN1306A4	6 X A4	2
USBN1109A4	USBN1209A4	USBN1409A4	USBN1309A4	9 X A4	2
USBN1112A4	USBN1212A4	USBN1412A4	USBN1312A4	12 X A4	2



Door lock!

Suitable for indoor use. It has 2 different backing models. Each unit includes a free set of pins or magnets. Single key 4xA4, double key 6xA4, 9xA4 and 12xA4 Sizes are available and can be used both in Portrait & Landscape positions. The cover can be opened to 90 degrees. Each unit includes mounting screw and plugs for easy wall mounting. The depth of the case is 35 mm. One set of 2 key included in the pack.

MATERIAL: Silver anodised aluminium				
CORK	MAGNETIC	CAPACITY	KEY	
USBN4004A4	USBN5004A4	4 X A4	2	
USBN4006A4	USBN5006A4	6 X A4	2	
USBN4009A4	USBN5009A4	9 X A4	2	

OFFICE BOARDS

Suitable for outdoor use. LEDs on the top and the bottom of the profile illuminate the interior of the frame. 4x A4, 6x A4, 9x A4, 12x A4 paper capacity sizes are available. Noticeboard can be used both in portrait and landscape positions. Each unit includes a free set of pins or magnets. The profile width is 70 mm and the depth of the case 50 mm. One set of 2 key included in the pack!

NOTICEBOARDS



Cork

M&C

Magnetic

Cork - Magnetic - M&C

MATERIAL: Silver anodised aluminium

CORK	MAGNETIC	M&C	CAPACITY
UNBN0004A4	UNBN1004A4	UNBN2004A4	4 X A4
UNBN0006A4	UNBN1006A4	UNBN2006A4	6 X A4
UNBN0009A4	UNBN1009A4	UNBN2009A4	9 X A4
UNBN0012A4	UNBN1012A4	UNBN2012A4	12 X A4



Soft edge corner
50 mm thickness

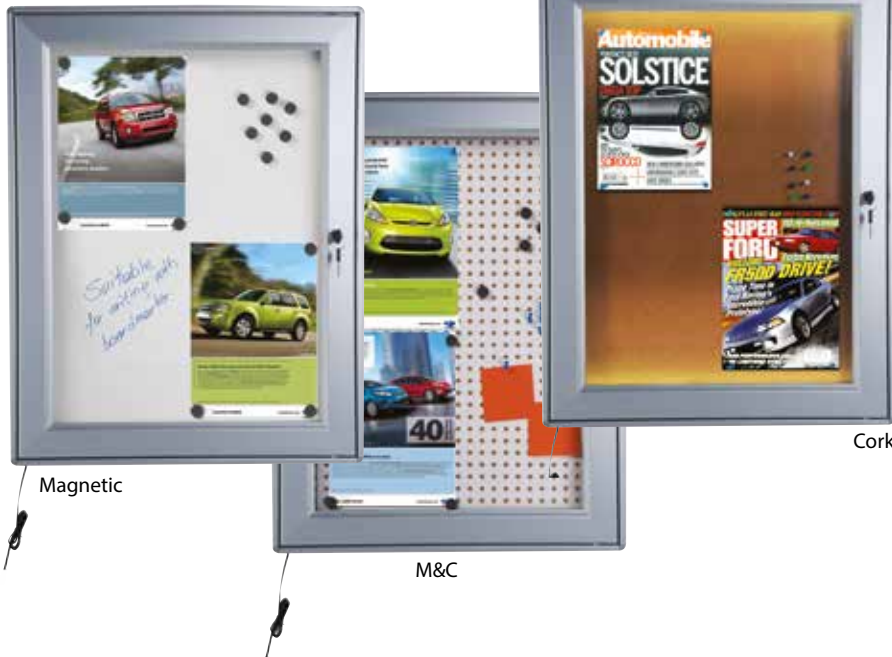

Magnetic

Cork

M&C

With LED Light

MATERIAL: Silver anodised aluminium

CORK	MAGNETIC	M&C	CAPACITY
UNBNL04A4	UNBN1L04A4	UNBN2L04A4	4 X A4
UNBNL06A4	UNBN1L06A4	UNBN2L06A4	6 X A4
UNBNL09A4	UNBN1L09A4	UNBN2L09A4	9 X A4



Cable

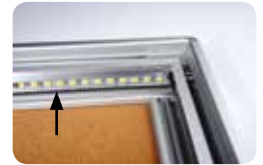

LED



With Logo

MATERIAL: Silver anodised aluminium

CORK	MAGNETIC	CAPACITY	DESCRIPTION
UNBN0504A4	UNBN1504A4	4 X A4	Portrait
UNBN0506A4	UNBN1506A4	6 X A4	Portrait
UNBN0509A4	UNBN1509A4	9 X A4	Portrait
UNBN0512A4	UNBN1512A4	12 X A4	Portrait
UNBN0704A4	UNBN1704A4	4 X A4	Landscape
UNBN0706A4	UNBN1706A4	6 X A4	Landscape
UNBN0709A4	UNBN1709A4	9 X A4	Landscape
UNBN0712A4	UNBN1712A4	12 X A4	Landscape



Magnetic

Cork



Black rubber

Clear cover

Stays keep the door open

Logo

Our Textile Frame Range consists of mainly 5 different profile options. These profiles are designed to make 3 different models of Single Sided TEXTILE FRAMES, and 2 models of Double Sided TEXTILE FRAMES. Our standard Textile Frames are always supplied unassembled providing connectors, hanging parts. For the double sided ceiling hanger model, the hanging wire cable system is included in each box. Please note, ceiling hanger and 4 feet options should be ordered separately.

TEXTILE FRAMES



Profiles of Textile Frames

Valet Profile

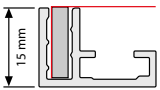
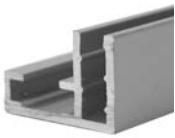

Article: UYUP014103
Valet Profile: 15x22 mm profile. The Single Sided TEXTILE FRAMES made up with Valet Profile are named as VALET TEXTILE FRAMES.

Ace Profile

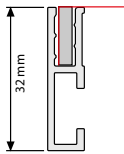

Article: UYUP014105
Ace Profile: 32x8mm profile. The Single Sided TEXTILE FRAMES made up with Ace Profile are named as ACE TEXTILE FRAMES.

Dame Profile

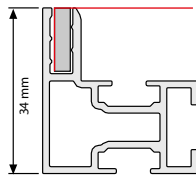

Article: UYUP014102
Dame Profile: 34x32 mm profile. The Single Sided TEXTILE FRAMES made up with Dame Profile are named as DAME TEXTILE FRAMES.

Queen Profile

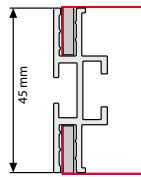

Article: UYUP014104
Queen Profile: 45x15 mm profile - Suitable for ceiling suspension. The Double Sided TEXTILE FRAMES made up with Queen Profile are named as QUEEN TEXTILE FRAMES.

King Profile

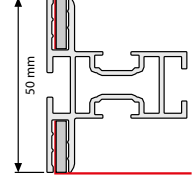
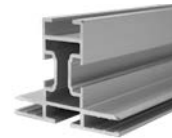

Article: UYUP014101
King Profile: 50x40 mm profile - Designed with feet for free standing. The Double Sided TEXTILE FRAMES made up with King Profile are named as KING TEXTILE FRAMES.

H Profile

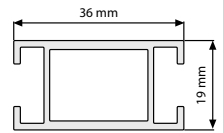

Article: UYUP014106
H Profile: 36 x19 mm, 3 meters. Suitable for Ace, Dame, Queen and King profiles.

ALL PROFILES ARE AVAILABLE IN LENGTHS OF 3 OR 6 METERS WITH ALL CORNERS AND MOUNTING PARTS AS MENTIONED BELOW



Article: UYUP412310
Corner Connector
To use with: Queen, Ace, King and Dame Textile Frames.



Article: UYUP412295
Corner Cleat
To use with: King and Dame Textile Frames.



Article: UYUP412270
Square corner connector
To use with: Queen and Ace Textile Frames.



Article: UYUP412291
Straight cleat for H-Profile
To use with: Queen, Ace, King and Dame Textile Frames.



Article: UYUP025010
L-type corner connector
To use with: Valet Textile Frames.



Article: UYUP412320
Coupling head
To use with: Queen, Ace and King Textile Frames.



Article: UYUP412330
Coupling head
To use with: Dame Textile Frames.



Article: UYUP460235
Nylon strip without tape
To use with: Queen, Ace, King, Valet and Dame Textile Frames.



Article: UYUP460220
Nylon strip with tape
To use with: Queen, Ace, King, Valet and Dame Textile Frames.



Double sided

Valet Textile Frame

MATERIAL: Silver anodised aluminium

ARTICLE	EXTERNAL (x-y)
UMFR0000A4	210 X 297 mm
UMFR0000A3	297 X 420 mm
UMFR0000A2	420 X 594 mm
UMFR0000A1	594 X 841 mm
UMFR0000B2	500 X 700 mm
UMFR0000B1	700 X 1000 mm
UMFR000510	500 X 1000 mm

Dame Textile Frame

MATERIAL: Silver anodised aluminium

ARTICLE	EXTERNAL (x-y)	*H (mm)	*H (Pcs)
UMFG001020	1000 X 2000 mm	-	-
UMFG001030	1000 X 3000 mm	936 mm	1
UMFG001520	1500 X 2000 mm	-	-
UMFG001530	1500 X 3000 mm	1436 mm	1
UMFG002020	2000 X 2000 mm	-	-
UMFG002030	2000 X 3000 mm	1936 mm	2

*H: H profile

Ace Textile Frame

MATERIAL: Silver anodised aluminium

ARTICLE	EXTERNAL (x-y)	*H (mm)	*H (Pcs)
UMFB0000A4	210 X 297 mm	-	-
UMFB0000A3	297 X 420 mm	-	-
UMFB0000A2	420 X 594 mm	-	-
UMFB0000A1	594 X 841 mm	-	-
UMFB0000A0	841 X 1189 mm	-	-
UMFB0000B2	500 X 700 mm	-	-
UMFB0000B1	700 X 1000 mm	-	-
UMFB0000B0	1000 X 1400 mm	983 mm	1
UMFB000510	500 X 1000 mm	-	-
UMFB001010	1000 X 1000 mm	-	-
UMFB001015	1000 X 1500 mm	983 mm	1
UMFB001020	1000 X 2000 mm	983 mm	1

*H: H profile

Queen Textile Frame

MATERIAL: Silver anodised aluminium

ARTICLE	EXTERNAL (x-y)	*H (mm)	*H (Pcs)
UMFL0000A4	210 X 297 mm	-	-
UMFL0000A3	297 X 420 mm	-	-
UMFL0000A2	420 X 594 mm	-	-
UMFL0000A1	594 X 841 mm	-	-
UMFL0000A0	841 X 1189 mm	-	-
UMFL0000B2	500 X 700 mm	-	-
UMFL0000B1	700 X 1000 mm	-	-
UMFL0000B0	1000 X 1400 mm	970 mm	1
UMFL000510	500 X 1000 mm	-	-
UMFL001010	1000 X 1000 mm	-	-
UMFL001015	1000 X 1500 mm	970 mm	1
UMFL001020	1000 X 2000 mm	970 mm	1

*H: H profile



Textile Frame with Led

MATERIAL: Silver anodised aluminium

ARTICLE	EXTERNAL (x-y)	*H (mm)	*H (Pcs)	LIGHTING
UMLD3400A4	210 X 297 mm	-	-	2200-2400 LUX
UMLD3400A3	297 X 420 mm	-	-	2200-2400 LUX
UMLD3400A2	420 X 594 mm	-	-	2200-2400 LUX
UMLD3400A1	594 X 841 mm	-	-	2200-2400 LUX
UMLD3400A0	841 X 1189 mm	-	-	2000-2200 LUX
UMLD3400B2	500 X 700 mm	-	-	2200-2400 LUX
UMLD3400B1	700 X 1000 mm	-	-	2000-2200 LUX
UMLD3400B0	1000 X 1400 mm	936 mm	1	-
UMLD340023	508 X 762 mm	-	-	2200-2400 LUX
UMLD340034	762 X 1016 mm	-	-	2000-2200 LUX
UMLD340046	1016 X 1524 mm	952 mm	1	-

*H: H profile



Double sided



Hanging kit
UYUP460245

King Textile Frame

MATERIAL: Silver anodised aluminium

ARTICLE	EXTERNAL (x-y)	*H (mm)	*H (Pcs)
UMFO001014	1000 X 1400 mm	-	-
UMFO001015	1000 X 1500 mm	-	-
UMFO001020	1000 X 2000 mm	-	-
UMFO001022	1000 X 2250 mm	920 mm	1
UMFO002015	2000 X 1500 mm	-	-
UMFO002020	2000 X 2000 mm	-	-
UMFO002022	2000 X 2250 mm	1920 mm	1
UMFO003015	3000 X 1500 mm	1420 mm	1
UMFO003020	3000 X 2000 mm	1920 mm	2
UMFO003022	3000 X 2250 mm	2170 mm	2

*H: H profile



Feets of Textile Frames (To be used with Double Sided King Profile)



Article: UYUP412271
Circle Ø 450 x 6mm
single packed.



Article: UYUP412273
Baseball 450 x 300 x 6mm
single packed.



Article: UYUP412272
Hoop Ø 450 x 6mm
single packed.



Article: UYUP412274
Fillet 500 x 180 x 6mm
single packed.

It is an economical and easy-to-use product. You just can put in your PVC foam poster with 5 to 10mm thickness and adjust the nut of fixing from the bottom part of the aluminum box. It can be used in all indoor areas such as schools, seminars, restaurant chains, showrooms, exhibition areas, malls and everywhere else.

EASY SWAP



Fixing nut

MATERIAL : Silver anodised aluminium

ARTICLE	POSTER
UMS0100300	300 mm
UMS0100600	600 mm
UMS0100800	800 mm
UMS0100900	900 mm
UMS0101000	1000 mm
UMS0101200	1200 mm
UMS0101500	1500 mm



Adjustable thickness



MATERIAL : Silver, powder coated in RAL 9006

ARTICLE	POSTER
UMS0000300	300 mm
UMS0000600	600 mm
UMS0000800	800 mm
UMS0000900	900 mm
UMS0001000	1000 mm

The system is mainly based on screwing the 2 pieces of the bases to each other to stand the poster still. Adjustable thickness of poster. The maximum height of poster is 150 cm. Base is double sided printable. Suitable for all indoor areas such as schools, seminars, restaurant chains, showrooms, exhibition areas, malls and everywhere else.

POSTER TRAP

Retractable poster displays system. These Roll banners are made of aluminum with the finest craftsmanship and got stylish edge finishes. It is easy to install and requires no tools to set up. Retractable system provides protection during transportation. The base houses the poster and feet. Removable retractable system is ideal for applications where the message changes regularly.

BUDGET ROLL BANNER



Top clamp profile



MATERIAL : Silver anodised aluminium

ARTICLE	POSTER	DESCRIPTION
CNFA-C-0280	800X2000 mm	with bag
CNFA-C-0285	850X2000 mm	with bag
CNFA-C-0290	900X2000 mm	with bag
CNFA-C-0210	1000X2000 mm	with bag
CNFA-C-0212	1200X2000 mm	with bag

MATERIAL : Silver anodised aluminium

ARTICLE	POSTER	DESCRIPTION
CYDRS-80	800X2000 mm	with bag
CYDRS-85	850X2000 mm	with bag



new

Single-sided Roll Banner 200 x 85 cm carried out in aluminium housing with chrome end caps and 3-piece magnetic pipe. At the top a clamping profile and the bottom with adhesive strip. Leveling feet. Delivered in a padded bag.

LUXURIOUS ROLL BANNER



Complete with black padded carry bag.



MATERIAL : Silver anodised aluminium

ARTICLE	POSTER	WEIGHT
CWKS-RS-19	850X2000 mm	3340 gr.

new

Single-sided Roll Banner 200 x 85 cm aluminium 3-piece pipe. At the top a clamping profile and at the bottom with adhesive strip. At the rear with extra reinforcement for the pipe. Delivered in a bag.

MUSQUITO ROLL BANNER



Complete with black carry bag.



MATERIAL : Silver anodised aluminium

ARTICLE	POSTER	WEIGHT
CWKS-N-RS-12	850X2000 mm	2540 gr.



Smart Roll Banner; With the latest revision on Smart Roll Banner, M&T concentrated on both design and outlook features of the product&functionality. Pipe fixation addition, improved end caps provide a more stable product and the new revised design gives a more elegant look to the product. The aluminum body is silver anodised, stands at min 1000 mm, has a unique telescopic pipe.

SMART ROLL BANNERS

Single Sided

MATERIAL : Silver anodised aluminium

ARTICLE	POSTER
URBSTOON82	800 mm
URBSTOON92	900 mm
URBSTOON12	1000 mm

Double Sided

MATERIAL : Silver anodised aluminium

ARTICLE	POSTER
URBSC00N82	800 mm
URBSC00N92	900 mm
URBSC00N12	1000 mm

Patent Pending
PCT/TR 2005/000044, EP 05801071
DE 20 2004 021 229 OHIM DM 084 128

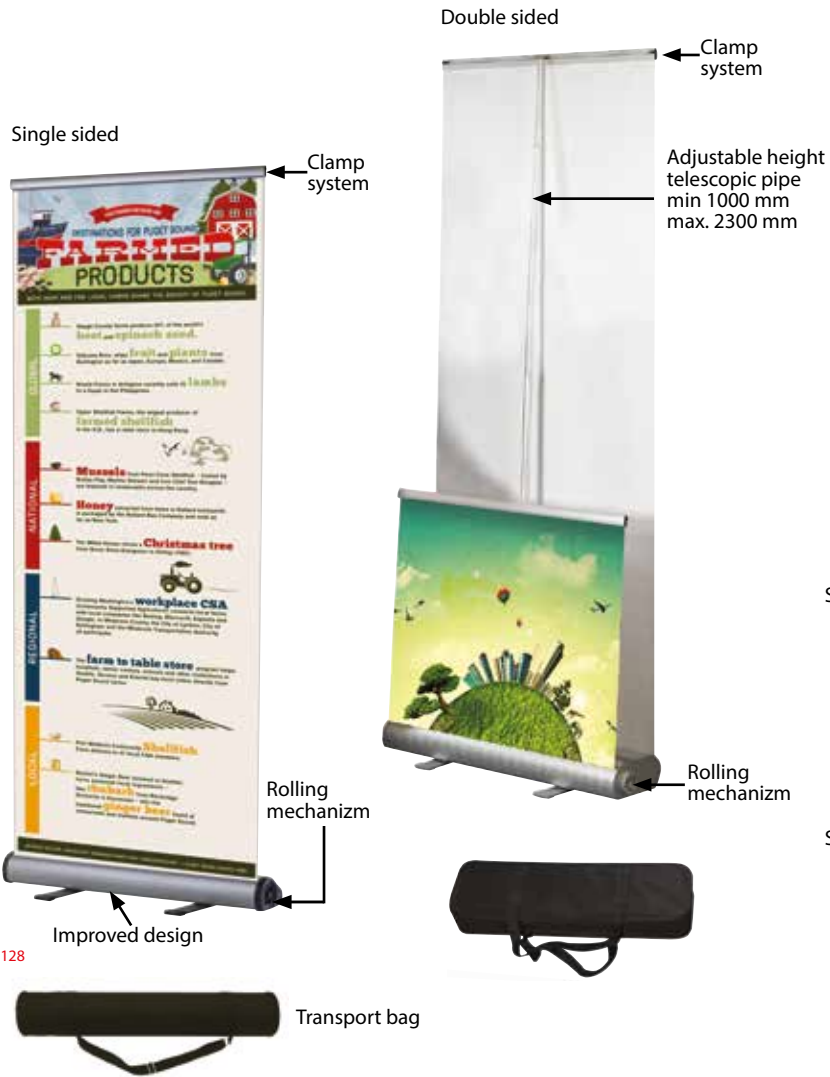

The rolling cylinder comes ready at the point available to place in the art work. After the placement of the art work, the cylinder runs immediately once the pin on one end is off. The rolling cylinder can be set up and stretched in the required tightness.

ECO ROLLER

MATERIAL : Silver anodised aluminium

ARTICLE	POSTER
URBETOON82	800 X 2000 mm
URBETOON12	1000 X 2000 mm

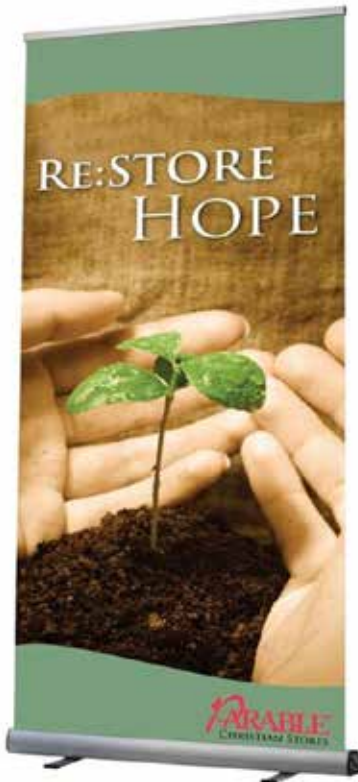

Retractable poster displays system. Easy to install and requires no tools to set up. Constructed in aluminium and has stylish edge finishes. Removable retractable system is ideal for applications where the message changes regularly. The base houses the poster and feet.

OPTIMA ROLLER

MATERIAL : Silver anodised aluminium

ARTICLE	POSTER
URB001N082	800 X 2050 mm
URB001N092	900 X 2050 mm



Newage Quick Banner display offers competitive solutions. Suitable to hold banners in thickness 50 micron / 500 micron. New Age Quick Banner is a flexible and mobile set that can be carried to conventions or exhibitions within its bag.

NEWAGE QUICK BANNER



Poster clamp system!



MATERIAL : Silver anodised aluminium

ARTICLE	POSTER
UQBETO0N62	600 X 2000 mm
UQBETO0N72	700 X 2000 mm
UQBETO0N82	800 X 2000 mm
UQBETO0N92	900 X 2000 mm
UQBETO0N12	1000 X 2000 mm

Quick banners provide practical and easy use of banners without any tool assembly. It is portable to fit in a small Size of textile carry bag. You can chose one of single of double sided Quick Banners.

QUICK BANNERS

Single Sided

MATERIAL : Silver anodised aluminium

ARTICLE	POSTER
UQBOTO0N72	700 X 2000 mm
UQBOTO0N82	800 X 2000 mm
UQBOTO0N92	900 X 2000 mm
UQBOTO0N12	1000 X 2000 mm

Patent Pending
TR 2005 01772

Double Sided

MATERIAL : Silver anodised aluminium

ARTICLE	POSTER
UQBOCO0N72	700 X 2000 mm
UQBOCO0N82	800 X 2000 mm
UQBOCO0N92	900 X 2000 mm
UQBOCO0N12	1000 X 2000 mm



Gray carry bag



Single sided

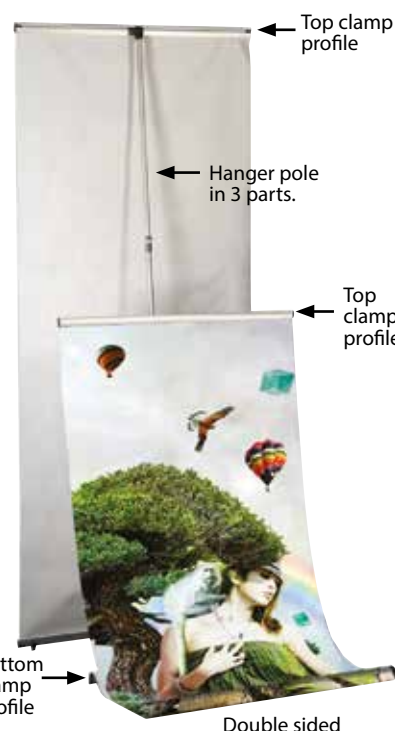

Double sided



poster clamp system no tape applied!



Single sided hanger



Double sided hanger



The height of the poster is flexible, can be adjusted up to 2 meters.

CROSS SINGLE BANNER

Hanger pole in 3 parts.



Gray carry bag

MATERIAL : Silver anodised aluminium

ARTICLE	POSTER
USBCO0N62	600 X max. 2000 mm
USBCO0N72	700 X max. 2000 mm
USBCO0N82	800 X max. 2000 mm

An ideal brochure stand that allows an indoor use of different models. The fixing grooves on both sides of the central pole hold single-sided or double-sided frames and shelves separately or collectively at the same time. The frames are recommended for use in 30 mm profiles in both Portrait or Landscape position.

FREE STANDING LEAFLET DISPLAY

Main Body Profile Type

2 Channel



Powder coated in RAL 9006

MAINBODY WITH 2 CHANNEL

ARTICLE	DESCRIPTION	SIZE
UFSL001000	Main body pole	1920 mm
	Main body base	Ø 450 mm

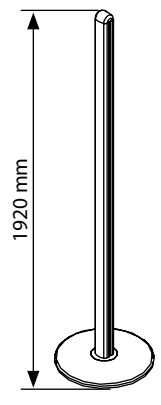

4 Channel

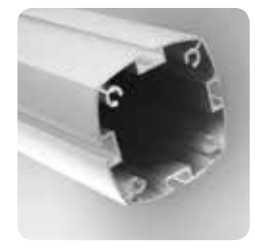

Powder coated in RAL 9006

MAINBODY WITH 4 CHANNEL

ARTICLE	DESCRIPTION	SIZE
UFSL001100	Main body pole	1920 mm
	Main body base	450 X 450 mm

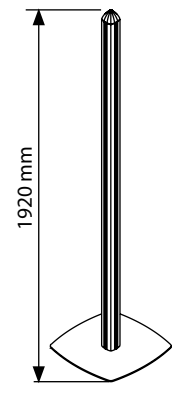

Snap Frame

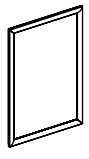

SNAP FRAME: 30 mm 45° - 30 mm round

MITRED ARTICLE	ROUND ARTICLE	POSTER
UFSL005000	UFSL011000	420 X 594 mm
UFSL004000	UFSL010000	594 X 841 mm
UFSL006000	UFSL012000	500 X 700 mm
UFSL008000	UFSL014000	700 X 1000 mm

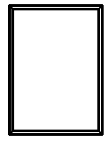

Slide-in Frame

MATERIAL : Silver anodised aluminium

ARTICLE	POSTER
UFSL130300	210 X 297 mm
UFSL130200	297 X 420 mm
UFSL130100	420 X 594 mm
UFSL130500	508 X 762 mm
UFSL130400	500 X 700 mm

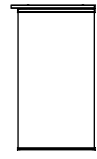

Banner

MATERIAL : Silver anodised aluminium

ARTICLE	POSTER
UFSL110000	400 mm
UFSL110100	500 mm
UFSL110200	600 mm
UFSL110300	700 mm

Header

MATERIAL : Opaque acrylic

ARTICLE	DESCRIPTION	SIZE
UFSL120200	Header	450 X 160 mm
UFSL120100	Header	350 X 160 mm



Shelf

STEEL & ACRYLIC SHELF

ARTICLE	CAPACITY
UFSL002000	2 X A4 steel shelf
UFSL003000	2 X A4 acrylic shelf

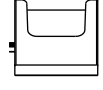

MATERIAL: Clear Acrylic

ARTICLE	DESCRIPTION	SIZE
UFSL140000	Acrylic Shelf	A4
UFSL140100	Acrylic Shelf	A5
UFSL140200	Acrylic Shelf	1/3 A4



MATERIAL: Clear Acrylic

ARTICLE	DESCRIPTION	SIZE
UFSL120000	Acrylic Shelf	A4

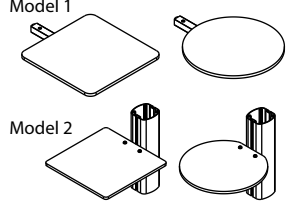

8 mm MDF SHELF

ARTICLE	SIZE	DESCRIPTION	WEIGHT CAPACITY
UFSL002500	Ø250 mm	Model 1 Circle	max. 1 kg
UFSL002510	250 X 250 mm	Model 1 Square	max. 1 kg
UFSL002550	Ø250 mm	Model 2 Circle	max. 5 kg
UFSL002560	250 X 250 mm	Model 2 Square	max. 5 kg



Some possible variations using 2 channel profile

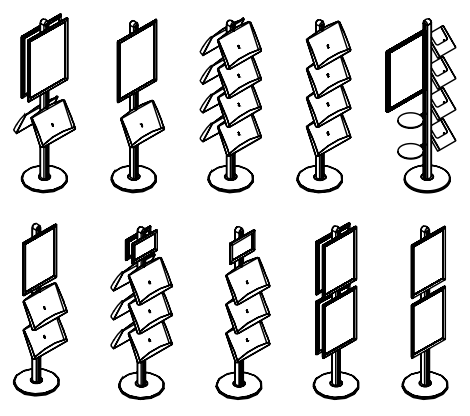

Some possible variations using 4 channel profile

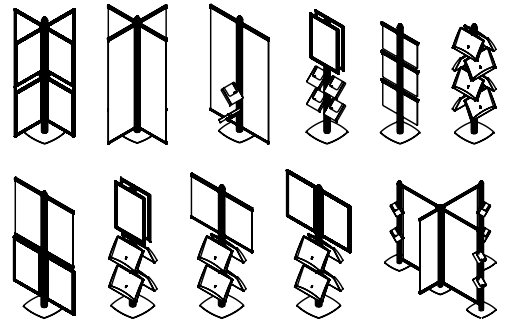

Leaflet Display



Banner set



Leaflet Dispensers



Leaflet With Side Shelves



Convex Box

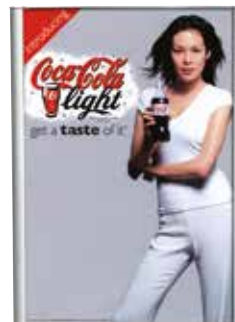

Snap open



MATERIAL : Silver anodised aluminium	
ARTICLE	POSTER
UTTM014100	420 X 594 mm
UTTM014000	594 X 841 mm
UTTM014200	500 X 700 mm
UTTM014300	508 X 762 mm

Easy to build, stylish brochure holder. Designed to hold various brochures fulfilling your personal wishes and needs. The connector structure offers you space for individual adjustment of the shelves. To complete a product, main body and required quantities of shelves need to be ordered separately.

COCTAIL BROCHURE SETS

MATERIAL : Silver anodised aluminium & acrylic shelf

ARTICLE	DESCRIPTION	SIZE
UCBSG00024	Main body	2 X A4
UCBSG00034	Main body	3 X A4
UMSDA008A4	Acrylic Shelf & Adapter	8 X A4
UMSD008000	Acrylic Shelf	A4
UYUP490000	Adapter	



Coctail Brochure Set for Wall

MATERIAL: Clear Acrylic

ARTICLE	POSTER	DESCRIPTION
UCBSW200A4	210 X 297 mm	A4 Portrait
UCBSW200A5	148 X 210 mm	A5 Portrait
UCBSW30A43	105 X 210 mm	1/3 A4 Portrait



Multiside Brochure sets are developed to provide multiple variations at low costs. Based on 1, 3 or 4 poles, robust aluminum body with height of 1,5 meters, various number of shelves can be fitted to make a brochure set meeting your exact needs. To complete a product, main body and required quantities of shelves need to be ordered separately. Brochure holders are quickly and easily inserted.

MULTISIDE BROCHURE SETS

Color options:
Silver & Black.



1 Pole - 3 Pole - 4 Pole

MATERIAL : Silver anodised aluminium & acrylic shelf

1 POLE	3 POLE	4 POLE	DESCRIPTION	SIZE
UMBSG205A4	UMBSG305A4	UMBSG405A4	Main body	5A4
UMBSG205A5	UMBSG305A5	UMBSG405A5	Main body	5A5
UMBSG20523	UMBSG30523	UMBSG40523	Main body	5X2A4/3
UMSDA005A4	UMSDA005A4	UMSDA005A4	Acrylic Shelf & Adapter	A4
UMSDA012A4	UMSDA012A4	UMSDA012A4	Acrylic Shelf & Adapter	A4
UMSDA000A5	UMSDA000A5	UMSDA000A5	Acrylic Shelf & Adapter	A5
UMSDA00A43	UMSDA00A43	UMSDA00A43	Acrylic Shelf & Adapter	1/3 A4
UMSDA02A43	UMSDA02A43	UMSDA02A43	Acrylic Shelf & Adapter	2X1/3 A4

On Wheels - Rotating

MATERIAL : Silver anodised aluminium & acrylic shelf

1 POLE	3 POLE	4 POLE ROTATING	DESCRIPTION	SIZE
UMBSG2T5A4	UMBSG3T5A4	UMBSG4D5A4	Silver main body	5A4
UMBBG2T5A4	UMBBG3T5A4	UMBBG4D5A4	Black main body	5A4
UMSDA005A4	UMSDA005A4	UMSDA005A4	Acrylic Shelf & Adapter	A4
UMSDA012A4	UMSDA012A4	UMSDA012A4	Acrylic Shelf & Adapter	A4
UMSDA000A5	UMSDA000A5	UMSDA000A5	Acrylic Shelf & Adapter	A5
UMSDA00A43	UMSDA00A43	UMSDA00A43	Acrylic Shelf & Adapter	1/3 A4
UMSDA02A43	UMSDA02A43	UMSDA02A43	Acrylic Shelf & Adapter	2X1/3 A4



Rapid Brochure set has a stylish look and eye-catching shelves. A4 shelves are made of frosted acrylic and easily placed on the aluminum poles. Boxed in flat with unassembled shelves, it guarantees easy and safe transportation. Display your leaflets in retail stores or merchandising settings

RAPID BROCHURE SET

A4 Size pocket



An elegant & classic clear stand to display an A4 size paper message on top, altering a pocket for literature packs in again an A4 size. Simple to change the message, eye-catching level of height. Suitable for use in galleries & showrooms accessible to the public.

MONOBLOCK

MATERIAL : Acrylic

ARTICLE	CAPACITY
UMNB001000	A4

Available in A4 Size in Portrait & Landscape positions. Decorative Brochure Stand Plus is delivered with easy to change header on top

DECORATIVE BROCHURE STAND & PLUS



MATERIAL : Silver anodised aluminium & acrylic

ARTICLE	DESCRIPTION
UDBS20Y0A4	A4 Landscape with Logo
UDBS20D0A4	A4 Portrait with Logo
UDBS10Y0A4	A4 Landscape
UDBS10D0A4	A4 Portrait



A4 Landscape with logo A4 Landscape

A4 Portrait with logo A4 Portrait



MATERIAL : Silver anodised aluminium & acrylic shelf

ARTICLE	CAPACITY
UBSSC10N24	16 X A4 double sided
UBSST10N24	8 X A4 single sided
UBSSC10N34	24 X A4 double sided
UBSST10N34	12 X A4 single sided
UBSSC10N44	32 X A4 double sided
UBSST10N44	16 X A4 single sided
UBSSD10N24	8 X A4 for wall

A brochure holder designed to keep minimum 6 / maximum 32 brochures at the same time in stores, galleries and banks. When used with 4 wheels it is free and mobile. Single or double sided options are available. Transparent shelves do not block the brochures or magazines.

BROCHURE SETS

Perfect for displaying A4 or 8,5"x11" literatures to your customers and potential clients. You have clear or aluminium stand as well as single or double side options. Choose one of our offerings to fit your request!

ZICK-ZACKS

Zick-Zack

MATERIAL : Silver anodised aluminium
SHELF: Acrylic

ARTICLE	MODEL	CAPACITY
UZZTAC1001	Single leg	6 X A4
UZZTAC1002	Single leg with header	6 X A4
UZZCAC1002	Double Leg	6 X A4

10 mm acrylic shelf width
225 mm



Single Leg Zick-Zack

225 mm
148 mm



Double Leg Zick-Zack with Header

218 mm
165 mm
Logo header with snap open profile



Single Leg Zick-Zack with Header

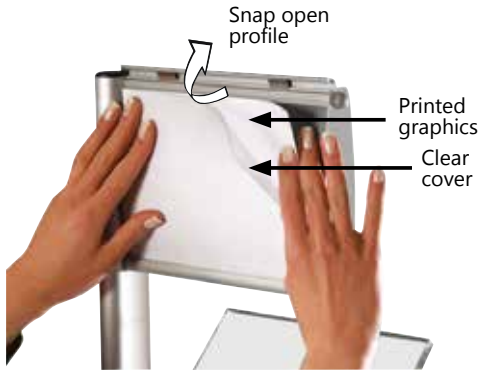

218 mm
165 mm
Logo header with snap open profile

8 mm acrylic shelf width
225 mm



Single Leg Zick-Zack Lite

8 mm acrylic shelf width
225 mm



Single Leg Zick-Zack Lite with Header

Lock the shelf



Logo header
175 x 230 mm

Lock the shelf



Acrylic



Aluminum

Zick-Zack Lite

MATERIAL : Silver anodised aluminium
SHELF: Acrylic

ARTICLE	MODEL	CAPACITY
UZZTLT0001	Single leg	6 X A4
UZZTLT0002	Single leg with header	6 X A4

Newage Portable

MATERIAL : Clear & Grey RAL 9006

ARTICLE	SIZE	DESCRIPTION
UZZEPS0100	5 X A4	with bag
UZZEPS0000	5 X A4	without bag
UYUP072400	5 X A4	Bag



Textile transport bag

Portable

MATERIAL : RAL 9006 powder coated aluminium & clear SHELF: Aluminium & acrylic options

ARTICLE	MODEL	CAPACITY
UZZPAL0001	Aluminium	3 X A4
UZZPAC0001	Acrylic	3 X A4
UYUP072000	Bag	3 X A4



Textile transport bag

Smart and elegant iPad stands are suitable for iPad2, 3, 4 and Air generations. All are adjustable to portrait and landscape positioning. Tablet is secure in starkey locked holder. 3m long USB cable is included in the kiosks for your comfortable use.

KIOSKS FOR iPad

Novel Kiosk for Wall & Freestanding

MATERIAL : Silver & Black anodised aluminium

ARTICLE	DESCRIPTION
UPDNW0W00	for Wall / White
UPDNW0B00	for Wall / Black
UPDNF0W00	for Freestanding / White
UPDNF0B00	for Freestanding / Black



One product, two positions (landscape & portrait)

Curved Kiosk

MATERIAL : Silver & Black anodised aluminium

ARTICLE	DESCRIPTION
UPDC0B0W00	White
UPDC0B0B00	Black

One product, two positions (landscape & portrait)



Novel Kiosk

MATERIAL : Silver & Black anodised aluminium

ARTICLE	DESCRIPTION
UPDN0N0W00	White
UPDN0N0B00	Black



in & out adjustable base



Desktop Kiosk

MATERIAL : Silver & Black anodised aluminium

ARTICLE	DESCRIPTION
UPDMON0W00	White
UPDMON0B00	Black

One product, two positions (landscape & portrait)



Pads to protect iPad from stretches

Lockable iPad Stand

MATERIAL : ABS & Aluminium & Steel

ARTICLE	DESCRIPTION
TLLP125001	Black



Case lockable



Base steel 440x350mm

Flexible Kiosk

MATERIAL : Silver anodised aluminium

ARTICLE	DESCRIPTION	HEIGHT MAX.	HEIGHT MIN.
UPDFON0W00	Adjustable Height / White	1095 mm	785 mm
UPDFON0B00	Adjustable Height / Black	1095 mm	785 mm
UPDFON1W00	Fixed Height / White	-	-
UPDFON1B00	Fixed Height / Black	-	-

One product, two positions (landscape & portrait)

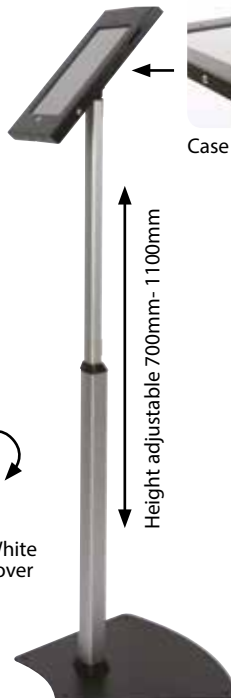
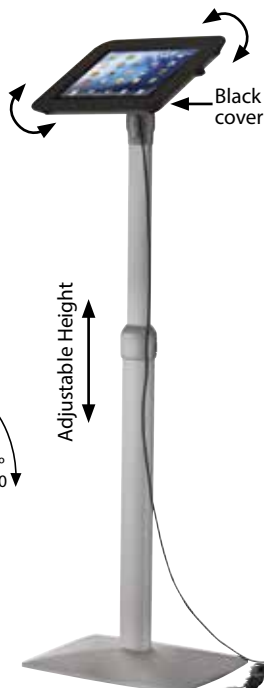

Height adjustable 700mm-1100mm

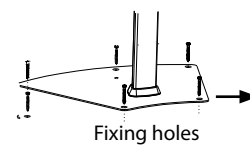

Fixing holes



Landscape & Portrait lock



Height adjusting



UYPPD0000
Lightning to 30-pin adapter. Packed by 10 pcs. You can use all type of Kiosk for iPad 4 too.



TZZZ998701
Cable lock kit for iPad 2100mm.

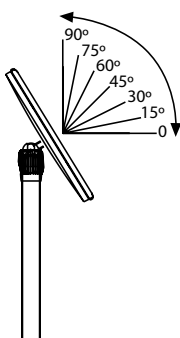

Adjustable Height

Panset exhibition system is a portable & user friendly assembled Panel construction. The durable framework of Panset can be positioned between 0-360° The framework of the construction can be easily unassembled to permit a quick change of the Panel inside.

PANSET

MATERIAL : Silver anodised aluminium
Panel: Plastech PVC Foam

ARTICLE	PANEL	HEADER
UPNS000035	700 X 1000 mm	300 X 700 mm
UPNS000034	700 X 1000 mm	300 X 700 mm
UPNS000033	700 X 1000 mm	300 X 700 mm



3x5 / 3x4 / 3x3 Panset

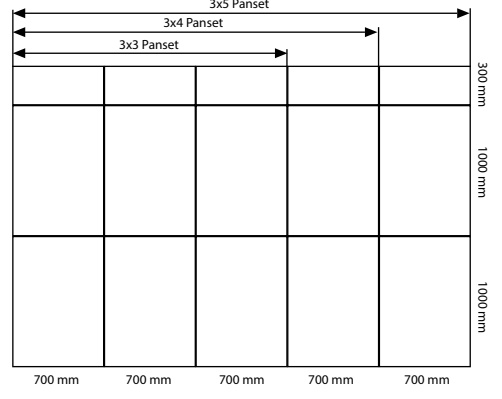

Bag / UYUP076100
Panset black carry bag for main body for all size. Don't forget to order.



Bag / UYUP075100
Panset black carry bag for logo for all size. Don't forget to order.

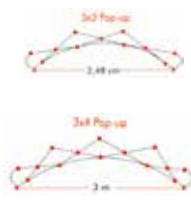

Pop-up stands are still the most popular standard display for large graphic displays. They are easy to transport, light weight, simple pop-ups and packable into a roto-molded plastic carry bag for transportation. Pop-up displays have a variety of sizes 3x3, 3x4. Panels are fitted to create a round display. Lights are included.

POP-UP MAGNETIC

Pop-up textile is a popular display for large graphic displays. Easy to transport, light weight, simple pop-ups and packable into a nylon carry bag for transportation. Pop-up textile is available in sizes 3x3, 3x4.

POP-UP TEXTILE

POP-UP TEXTILE

ARTICLE	Model
CNV33	Textile Pop Up 3x3 (with bag)
CNV34	Textile Pop Up 3x4 (with bag)

POP-UP MAGNETIC

ARTICLE	Model
CNP33	Pop Up 3x3 (with Bag)
CNP34	Pop Up 3x4 (with Bag)

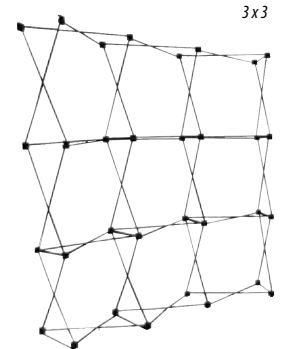
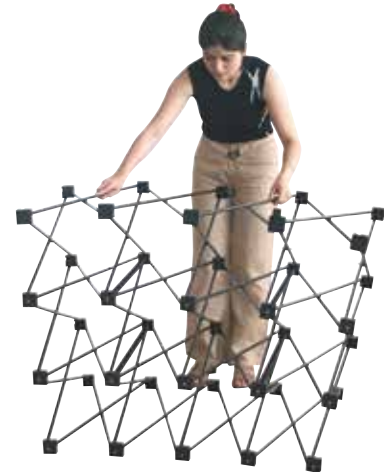
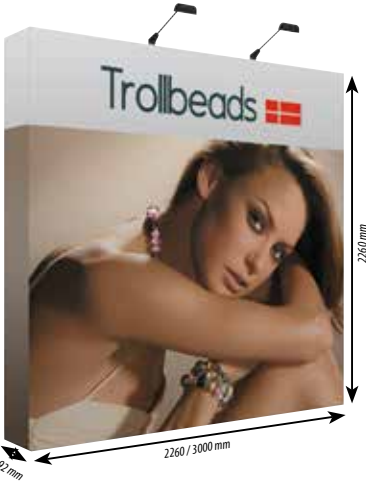

Panset counters are ideal products with a light & compact structure. They can be carried to different locations and re-used many times. It is easy and quick to install. Different models meet your needs in the most convenient manner. These counters are lightweight and when unassembled can even fit into trunk of a car.

PANSET COUNTER



Hexagonal

MATERIAL : Silver anodised aluminium
PANEL: Plastech PVC Foam

ARTICLE	MODEL	PANEL	QUANTITY
UPSM001000	Hexagonal	878 X 659 mm	1
		878 X 311 mm	4
UPSM007000	Wood Hexagonal	878 X 659 mm	1
		878 X 311 mm	4



Transport bag / UYUP074100

Max. carriage capacity 15 kg.



Max. carriage capacity 20 kg.

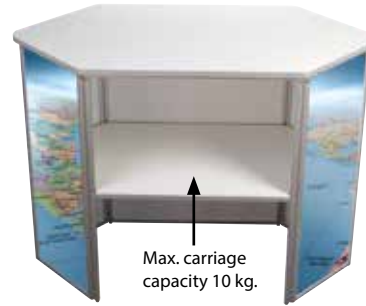
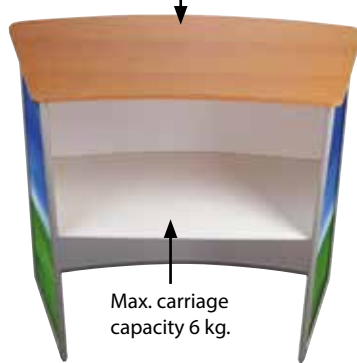

Max. carriage capacity 15 kg.



Convex

MATERIAL : Silver anodised aluminium
PANEL: Plastech PVC Foam

ARTICLE	MODEL	PANEL	QUANTITY
UPSM002000	Convex	878 X 980 mm	1
		878 X 430 mm	2
UPSM008000	Wood Convex	878 X 980 mm	1
		878 X 430 mm	2



Transport bag / UYUP074000

Midsize Convex

MATERIAL : Silver anodised aluminium
PANEL: Plastech PVC Foam

ARTICLE	PANEL	QUANTITY
UPSMOS2000	718 X 878 mm	1
	335 X 878 mm	2



Transport bag / UYUP070200

Lightweight, portable and cost-effective-display counters.

PROMOSTANDS

Large Promostand

MATERIAL : Plastic

ARTICLE	DESCRIPTION	PANEL SIZE
UTS00N5000	Without bag	2004 X 900 mm
UTS00N5100	With bag	2004 X 900 mm
UYUP072200	Bag	

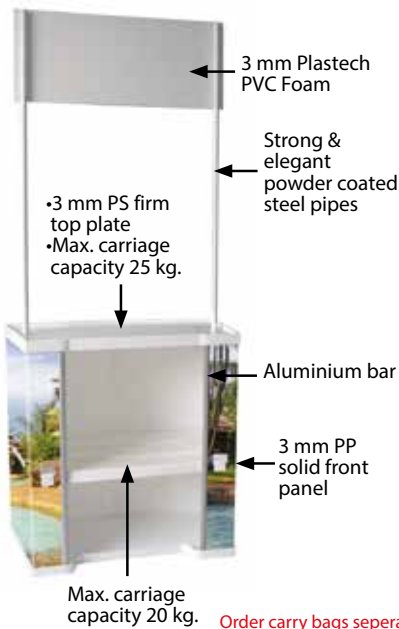

Petit Promostand

MATERIAL : Plastic

ARTICLE	DESCRIPTION	PANEL SIZE
UTS00N3000	Without bag	1596 X 900 mm
UTS00N3100	With bag	1596 X 900 mm
UYUP072300	Bag	

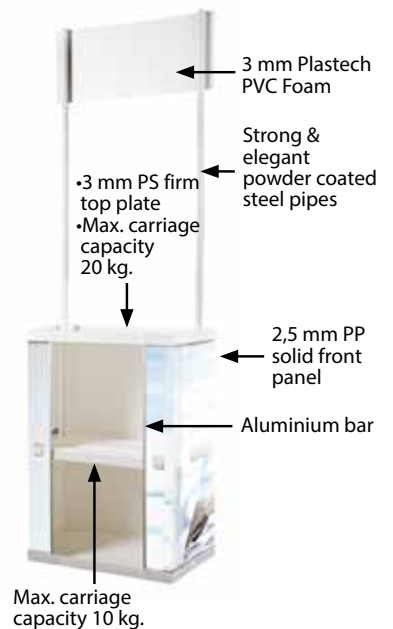

Highly resistant transparent document holders are suitable for the display of all types of documents such as catalogues, brochures, cards for every need, etc... These high quality clear leaflet dispensers can be branded with logo on your request. Various sizes as well as single or multiple tier are offered for your needs.

LEAFLET DISPENSERS

Leaflet Dispenser

MATERIAL : Clear		
ARTICLE	POSTER	DESCRIPTION
UMSD001005	210 X 297 mm	A4 Portrait
UMSD001004	148 X 210 mm	A5 Portrait
UMSD001003	100 X 210 mm	1/3 A4 Portrait



A4 Size

1/3 A4 Size

Multiple Pocket

MATERIAL : Clear		
ARTICLE	POSTER	DESCRIPTION
UMSD003000	210 X 297 mm	A4 X 3 Portrait
UMSD003050	100 X 210 mm	1/3 A4 X 4 Portrait
UMSD004000	148 X 210 mm	A5 X 3 Portrait
UMSD005000	100 X 210 mm	1/3 A4 X 3 Portrait

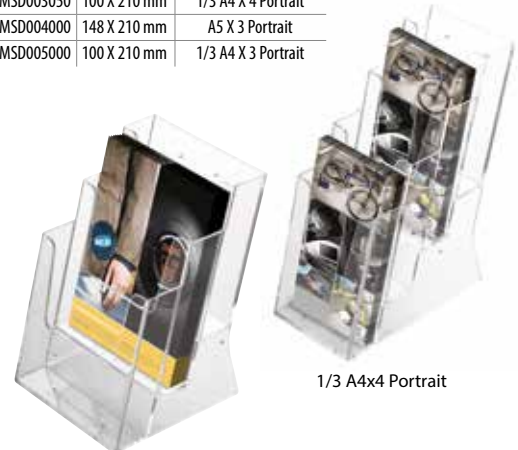

A4x3 Portrait

1/3 A4x4 Portrait

Wall Mount

MATERIAL : Clear		
ARTICLE	POSTER	DESCRIPTION
UMSD008100	210 X 297 mm	A4 Portrait
UMSD007000	148 X 210 mm	A5 Portrait
UMSD006000	100 X 210 mm	1/3 A4 Portrait
UMSD006010	100 X 210 mm	1/3 A4 X 2 Portrait



1/3 A4 X 2 Size



A4 Size

Business Card Holder

MATERIAL : Clear	
ARTICLE	DESCRIPTION
UMSD009000	Clear
UMSD009B00	Black
UMSD009T00	Turquoise

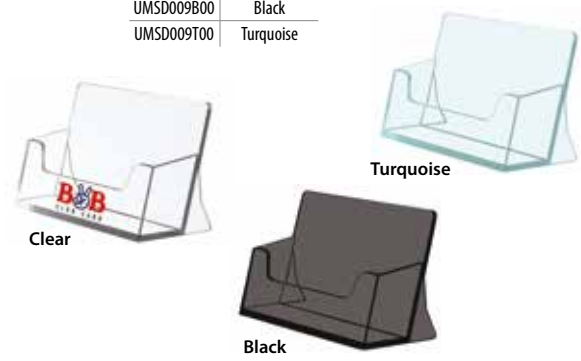

Clear

Turquoise

Black

Clear L Type

MATERIAL : Clear		
ARTICLE	POSTER	DESCRIPTION
UMSLD01000	210 X 297 mm	A4 Portrait
UMSLY01000	297 X 210 mm	A4 Landscape
UMSLD02000	148 X 210 mm	A5 Portrait
UMSLY02000	210 X 148 mm	A5 Landscape
UMSLD03000	105 X 148 mm	A6 Portrait
UMSLY03000	148 X 105 mm	A6 Landscape
UMSLD04000	100 X 210 mm	1/3 A4 Portrait
UMSLY04000	210 X 100 mm	1/3 A4 Landscape



A4 Portrait



1/3 A4 Portrait



A5 Landscape

Clear T Type

MATERIAL : Clear		
ARTICLE	POSTER	DESCRIPTION
UMSTD01000	210 X 297 mm	A4 Portrait
UMSTY01000	297 X 210 mm	A4 Landscape
UMSTD02000	148 X 210 mm	A5 Portrait
UMSTY02000	210 X 148 mm	A5 Landscape
UMSTD03000	105 X 148 mm	A6 Portrait
UMSTY03000	148 X 105 mm	A6 Landscape
UMSTD04000	100 X 210 mm	1/3 A4 Portrait
UMSTY04000	210 X 100 mm	1/3 A4 Landscape



A4 Portrait



A5 Landscape



A6 Landscape

The highly resistant transparent document holders are ideal for the display of menus at restaurants, price lists, etc... These high quality clear brochure holders can be screen printed with a corporate logo. Non-standard sizes can be produced according to customer specification & needs; for printing and quantities, please contact our sales department.

BROCHURE HOLDERS

Rocket

MATERIAL : Clear & Plastic Injection		
ARTICLE	POSTER	DESCRIPTION
UMSRD0GOA5	148 X 210 mm	Clear & Gray base
UMSRD0BOA5	148 X 210 mm	Clear & Black base



Upright

MATERIAL : Clear	
ARTICLE	POSTER
UMSDTLDN46	101,6 X 152,4 mm - 4" X 6" inch
UMSDTLDN57	127 X 177,8 mm - 5" X 7" inch
UMSDTLDN81	215,9 X 279,4 mm - 8,5" X 11" inch
UMSDTLDNA6	105 X 148 mm
UMSDTLDNA5	148 X 210 mm
UMSDTLDNA4	210 X 297 mm



A4 Portrait

Delta

MATERIAL : Clear	
ARTICLE	DESCRIPTION
UMSUD000A4	A4 Portrait
UMSUD000A5	A5 Portrait
UMSUD00A43	1/3 A4 Portrait
UMSUY000A5	A5 Landscape



A4 Portrait

Swing Wing

MATERIAL : Silver anodised aluminium & acrylic			
PORTRAIT	LANDSCAPE	POSTER	DESCRIPTION
USWMDNPOA7	USWMYNPA07	74 X 105 mm	Aluminium base & Acrylic
USWMDNPA43	USWMYNPA43	100 X 210 mm	Aluminium base & Acrylic
USWMDNPA06	USWMYNPA06	105 X 148 mm	Aluminium base & Acrylic
USWMDNPA05	USWMYNPA05	148 X 210 mm	Aluminium base & Acrylic
USWMDNPA04	USWMYNPA04	210 X 297 mm	Aluminium base & Acrylic



A5 Landscape

A4 Portrait

Foldable

MATERIAL : Clear	
ARTICLE	POSTER
UMSDFLDN46	101,6 X 152,4 mm - 4" X 6" inch
UMSDFLDN57	127 X 177,8 mm - 5" X 7" inch
UMSDFLDNA6	105 X 148 mm



5" X 7" Portrait

Oval

MATERIAL : Clear	
ARTICLE	POSTER
UMSDOLDN46	101,6 X 152,4 mm - 4" X 6" inch
UMSDOLDN57	127 X 177,8 mm - 5" X 7" inch
UMSDOLDN81	215,9 X 279,4 mm - 8,5" X 11" inch
UMSDOLDNA5	105 X 148 mm
UMSDOLDNA4	210 X 297 mm



A4 Portrait

L Type with Front Pocket

MATERIAL : Clear		
ARTICLE	POSTER	DESCRIPTION
UMSLDC1000	210 X 297 mm	A4 Portrait
UMSLYC1000	297 X 210 mm	A4 Landscape



A4 with Front Pocket Landscape



Clear sing holder, Cross Frame allows advertising many messages accepting 8 posters a time. Flat packed Cross Frame saves from space. Rounded corners provides elegant look to Cross Frame. Made of 2 mm clear acrylic.

CROSS FRAME

MATERIAL : Clear acrylic 2 mm		
ARTICLE	POSTER	CAPACITY
UMSCR004A5	148 X 210 mm	4 X A5
UMSCR004A6	105 X 148 mm	4 X A6



4 X A5 Size



Bottom part



Top part



Anti-clear high resistant PET transparent clear document holders. Ideal for the display of menus at the restaurants, price lists, etc... They are suitable for screen printing. Non standard sizes can be produced to customer specification & needs; for printing and quantities please contact our sales executives.

PET POCKET

PET Pocket , no tools required, mount it in less than a minute!

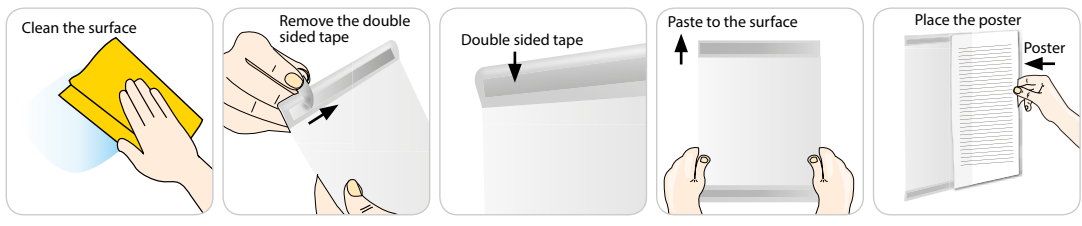

C TYPE : Clear		
ARTICLE	POSTER	DESCRIPTION
UPCC1D00A4	210 X 297 mm	A4 portrait
UPCC1Y00A4	297 X 210 mm	A4 landscape
UPCC1D00A5	148 X 210 mm	A5 portrait
UPCC1Y00A5	210 X 148 mm	A5 landscape
UPCC1D00A6	105 X 148 mm	A6 portrait
UPCC1Y00A6	148 X 105 mm	A6 landscape
UPCC1D00A7	74 X 105 mm	A7 portrait
UPCC1Y00A7	105 X 74 mm	A7 landscape

U TYPE : Clear			
WITHOUT TAPE	WITH TAPE	POSTER	DESCRIPTION
UPCU0D00A4	UPCU1D00A4	210 X 297 mm	A4 portrait
UPCU0Y00A4	UPCU1Y00A4	297 X 210 mm	A4 landscape
UPCU0D00A5	UPCU1D00A5	148 X 210 mm	A5 portrait
UPCU0Y00A5	UPCU1Y00A5	210 X 148 mm	A5 landscape
UPCU0D00A6	UPCU1D00A6	105 X 148 mm	A6 portrait
UPCU0Y00A6	UPCU1Y00A6	148 X 105 mm	A6 landscape
UPCU0D00A7	UPCU1D00A7	74 X 105 mm	A7 portrait
UPCU0Y00A7	UPCU1Y00A7	105 X 74 mm	A7 landscape

D TYPE : Clear		
ARTICLE	POSTER	DESCRIPTION
UPCD1D00A2	420 X 594 mm	A2 portrait
UPCD1Y00A2	594 X 420 mm	A2 landscape
UPCD1D00A3	297 X 420 mm	A3 portrait
UPCD1Y00A3	420 X 297 mm	A3 landscape
UPCD1D00A4	210 X 297 mm	A4 portrait
UPCD1Y00A4	297 X 210 mm	A4 landscape
UPCD1D00A5	148 X 210 mm	A5 portrait
UPCD1Y00A5	210 X 148 mm	A5 landscape
UPCD1D00A6	105 X 148 mm	A6 portrait
UPCD1Y00A6	148 X 105 mm	A6 landscape

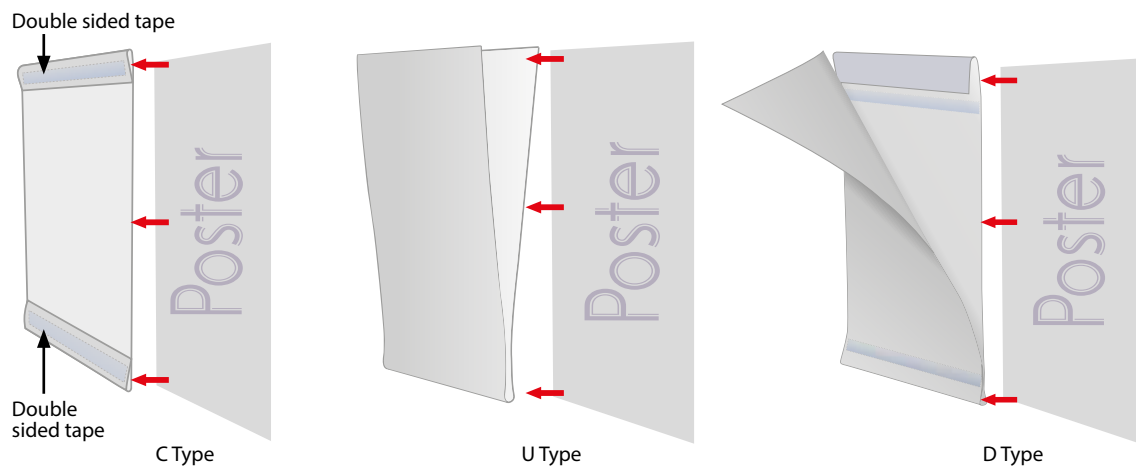

Easy Flex clamps are manufactured from high quality galvanised steel. Easy Flex is available in a range of three sizes – delivered from stock. Our Easy Flex clamps are easily fitted to existing structures and are simple to include in new projects. All clamps are TÜV certified.



EASY FLEX TUBE CONNECTORS



**Connection part
132 mm length**

MATERIAL : Aluminium

ARTICLE	DIAMETER
C00-33	33 mm
C00-42	42 mm
C00-48	48 mm



**Internal
Connector piece**

MATERIAL : Aluminium

ARTICLE	DIAMETER
C01-33	33 mm
C01-42	42 mm
C01-48	48 mm



90° Elbow

MATERIAL : Aluminium

ARTICLE	DIAMETER
C02-33	33 mm
C02-42	42 mm
C02-48	48 mm



Short T-piece

MATERIAL : Aluminium

ARTICLE	DIAMETER
C03-33	33 mm
C03-42	42 mm
C03-48	48 mm



Long T-piece

MATERIAL : Aluminium

ARTICLE	DIAMETER
C04-33	33 mm
C04-42	42 mm
C04-48	48 mm



**Internal T-piece
combination**

MATERIAL : Aluminium

ARTICLE	DIAMETER
C06-33	33 mm
C06-42	42 mm
C06-48	48 mm



Foot/Wallplate

MATERIAL : Aluminium

ARTICLE	DIAMETER
C11-33	33 mm
C11-42	42 mm
C11-48	48 mm



Footplate high

MATERIAL : Aluminium

ARTICLE	DIAMETER
C12-33	33 mm
C12-42	42 mm
C12-48	48 mm



Spacer

MATERIAL : Aluminium

ARTICLE	DIAMETER
C13-33	33 mm
C13-42	42 mm
C13-48	48 mm



**Spacer
lateral plate**

MATERIAL : Aluminium

ARTICLE	DIAMETER
C14-33	33 mm
C14-42	42 mm
C14-48	48 mm



Holder

MATERIAL : Aluminium

ARTICLE	DIAMETER
C15-33	33 mm
C15-42	42 mm
C15-48	48 mm



Distance holder

MATERIAL : Aluminium

ARTICLE	DIAMETER
C16-33	33 mm
C16-42	42 mm
C16-48	48 mm



Groundpot

MATERIAL : Aluminium

ARTICLE	DIAMETER
C17-33	33 mm
C17-42	42 mm
C17-48	48 mm



Wallclamp

MATERIAL : Aluminium

ARTICLE	DIAMETER
C18-33	33 mm
C18-42	42 mm
C18-48	48 mm



**Elbow 3-way
90°**

MATERIAL : Aluminium

ARTICLE	DIAMETER
C20-33	33 mm
C20-42	42 mm
C20-48	48 mm



**Cornerclamp 4-way
90°**

MATERIAL : Aluminium

ARTICLE	DIAMETER
C21-33	33 mm
C21-42	42 mm
C21-48	48 mm



**Connection part
2-way 90°**

MATERIAL : Aluminium

ARTICLE	DIAMETER
C22-33	33 mm
C22-42	42 mm
C22-48	48 mm



**Connection part
3-way 90°**

MATERIAL : Aluminium

ARTICLE	DIAMETER
C23-33	33 mm
C23-42	42 mm
C23-48	48 mm



**Connection part
4-way 90°**

MATERIAL : Aluminium

ARTICLE	DIAMETER
C24-33	33 mm
C24-42	42 mm
C24-48	48 mm



**2-way hinge
3-way clamp**

MATERIAL : Aluminium

ARTICLE	DIAMETER
C25-33	33 mm
C25-42	42 mm
C25-48	48 mm



**Clamping ring for
gathringe V**

MATERIAL : Aluminium

ARTICLE	DIAMETER
C31-33	33 mm
C31-42	42 mm
C31-48	48 mm



**Clamping ring for
gathringe M**

MATERIAL : Aluminium

ARTICLE	DIAMETER
C32-33	33 mm
C32-42	42 mm
C32-48	48 mm

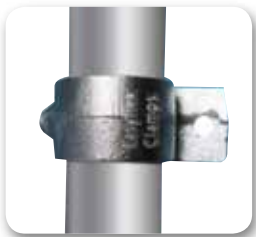

**Clamping ring for
plate mounting**

MATERIAL : Aluminium

ARTICLE	DIAMETER
C34-33	33 mm
C34-42	42 mm
C34-48	48 mm



**Clamping ring
with hook**

MATERIAL : Aluminium

ARTICLE	DIAMETER
C33-33	33 mm
C33-42	42 mm
C33-48	48 mm





Hinge part M (male)

MATERIAL : Aluminium

ARTICLE	DIAMETER
C35-33	33 mm
C35-42	42 mm
C35-48	48 mm



Hinge part V (female)

MATERIAL : Aluminium

ARTICLE	DIAMETER
C36-33	33 mm
C36-42	42 mm
C36-48	48 mm



Hinge part M (male) double

MATERIAL : Aluminium

ARTICLE	DIAMETER
C37-33	33 mm
C37-42	42 mm
C37-48	48 mm



Hinge part M (male) square

MATERIAL : Aluminium

ARTICLE	DIAMETER
C38-33	33 mm
C38-42	42 mm
C38-48	48 mm



Crosspart 90°

MATERIAL : Aluminium

ARTICLE	DIAMETER
C40-33	33 mm
C40-42	42 mm
C40-48	48 mm



Open T-part

MATERIAL : Aluminium

ARTICLE	DIAMETER
C41-33	33 mm
C41-42	42 mm
C41-48	48 mm



Brace clamp 2-leg

MATERIAL : Aluminium

ARTICLE	DIAMETER
C45-33	33 mm
C45-42	42 mm
C45-48	48 mm



Wall brace clamp

MATERIAL : Aluminium

ARTICLE	DIAMETER
C46-33	33 mm
C46-42	42 mm
C46-48	48 mm



Brace clamp 3-leg

MATERIAL : Aluminium

ARTICLE	DIAMETER
C47-33	33 mm
C47-42	42 mm
C47-48	48 mm

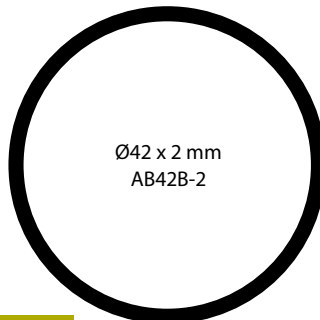
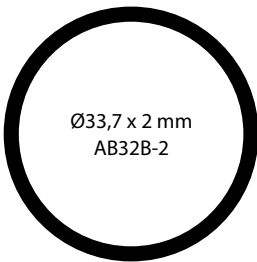

DIAMETER IN FULL SIZES

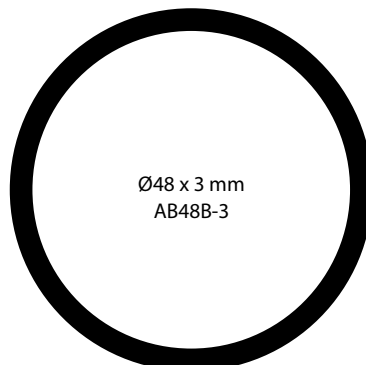
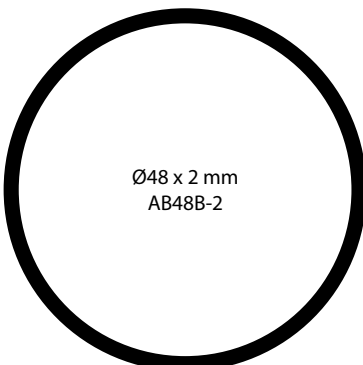

ALUMINIUM TUBES

ARTICLE	DESCRIPTION	DIAMETER	THICKNESS	LENGTH
AB32B-2-99	ALU TUBE	33,7 mm	2 mm	990 mm
AB32B-2-149	ALU TUBE	33,7 mm	2 mm	1490 mm
AB32B-2-199	ALU TUBE	33,7 mm	2 mm	1990 mm
AB32B-2-299	ALU TUBE	33,7 mm	2 mm	2990 mm
AB32B-2-6000	ALU TUBE	33,7 mm	2 mm	6000 mm
AB42B-2-6000	ALU TUBE	42 mm	2 mm	6000 mm
AB48B-2-99	ALU TUBE	48 mm	2 mm	990 mm
AB48B-2-149	ALU TUBE	48 mm	2 mm	1490 mm
AB48B-2-199	ALU TUBE	48 mm	2 mm	1990 mm
AB48B-2-299	ALU TUBE	48 mm	2 mm	2990 mm
AB48B-2-6000	ALU TUBE	48 mm	2 mm	6000 mm
AB48B-3	ALU TUBE	48 mm	3 mm	6000 mm



**Elbow molded
40-70°**

MATERIAL : Aluminium

ARTICLE	DIAMETER
C123-33	33 mm
C123-42	42 mm
C123-48	48 mm



**Angle termination
molded A7**

MATERIAL : Aluminium

ARTICLE	DIAMETER
C124-33	33 mm
C124-42	42 mm
C124-48	48 mm



2-way Hinge bus

MATERIAL : Aluminium

ARTICLE	DIAMETER
C125-33	33 mm
C125-42	42 mm
C125-48	48 mm



**Brace clamp
molded A3**

MATERIAL : Aluminium

ARTICLE	DIAMETER
C129-33	33 mm
C129-42	42 mm
C129-48	48 mm



**T-clamp open
hinged**

MATERIAL : Aluminium

ARTICLE	DIAMETER
C136-33	33 mm
C136-42	42 mm
C136-48	48 mm



**Cross clamp
hinged**

MATERIAL : Aluminium

ARTICLE	DIAMETER
C137-33	33 mm
C137-42	42 mm
C137-48	48 mm



**Cast iron combination
socket A30**

MATERIAL : Aluminium

ARTICLE	DIAMETER
C165-33	33 mm
C165-42	42 mm
C165-48	48 mm



**Cast iron 90° corner
Swivel combination**

MATERIAL : Aluminium

ARTICLE	DIAMETER
C168-33	33 mm
C168-42	42 mm
C168-48	48 mm

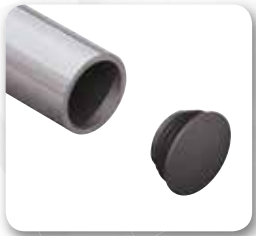

Pastic endcap

MATERIAL : Aluminium

ARTICLE	DIAMETER
C65-33	33 mm
C65-42	48 mm



**Mounting clip
single**

MATERIAL : Aluminium

ARTICLE	DIAMETER
C66-33	33 mm
C66-42	42 mm
C66-48	48 mm



**Mounting clip
double**

MATERIAL : Aluminium

ARTICLE	DIAMETER
C67-33	33 mm
C67-42	42 mm
C67-48	48 mm



**Cast iron
Swivel base section**

MATERIAL : Aluminium

ARTICLE	DIAMETER
C169M	universal



**Cast iron
locking Collar**

MATERIAL : Aluminium

ARTICLE	DIAMETER
C179-33	33 mm
C179-42	42 mm
C179-48	48 mm



**Universal joint
fixed key**

MATERIAL : Aluminium

ARTICLE	DIAMETER
ST1057-48	48 mm



**Scaffold coupling
fixed key**

MATERIAL : Aluminium

ARTICLE	DIAMETER
ST1126-48	48 mm



Easy Block

Use for firm anchoring in the soil of the Easy Flex system.

MATERIAL : Concrete

ARTICLE	DESCRIPTION
EASYBLOCK	Concrete block of 300x300x300 mm

These tensioners offers a variety of solutions for displaying both PVC banners and textile banners which are quick and easy to use.

TENSIONERS

new



Maximum pull 20 kg.
Length includes hook.

Z=Black
W=white

SpanFix Ø 4 mm

ARTICLE	DIAMETER	LENGTH
SPAN-4-17-Z	4 mm	17 cm
SPAN-4-17-W	4 mm	17 cm
SPAN-4-20-Z	4 mm	20 cm
SPAN-4-20-W	4 mm	20 cm
SPAN-4-25-Z	4 mm	25 cm
SPAN-4-25-W	4 mm	25 cm
SPAN-4-30-Z	4 mm	30 cm
SPAN-4-30-W	4 mm	30 cm



Maximum pull 47,1 kg.
Length includes hook.

Z=Black

Basic Ø 6 mm

ARTICLE	DIAMETER	LENGTH
SPAN15BASIC-Z	6 mm	15 cm
SPAN20BASIC-Z	6 mm	20 cm
SPAN25BASIC-Z	6 mm	25 cm



Maximum pull Ø 8 mm 62,7 kg.
Length includes hook.

Z=Black
W=White

Special Hook Ø 6-8 mm

ARTICLE	DIAMETER	LENGTH
SPAN10-Z	6 mm	11 cm
SPAN10-W	6 mm	11 cm
SPAN15-Z	6 mm	15 cm
SPAN18-Z	8 mm	18 cm
SPAN20-Z	8 mm	20 cm
SPAN23-Z	8 mm	23 cm
SPAN25-Z	8 mm	25 cm
SPAN25-W	8 mm	25 cm

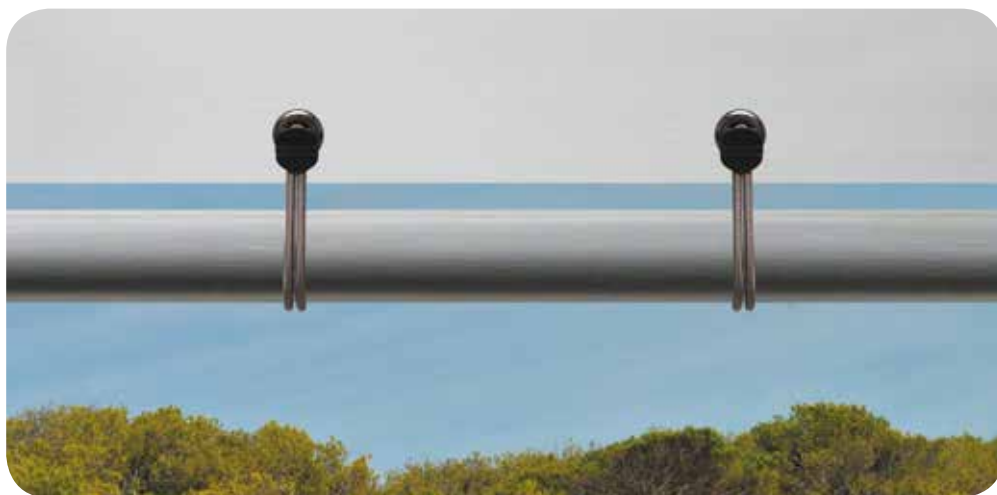

new

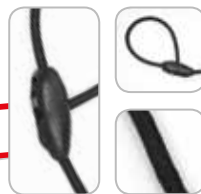

Maximum pull 20 kg.
Length includes hook.

Z=Black

FastFix Bungee Ø 5 mm

ARTICLE	DIAMETER	LENGTH
SFF-5-40-Z	5 mm	40 cm
SFF-5-150-Z	5 mm	150 cm



Maximum pull 100 kg.
Length includes ball.

Z=Black
W=White

Bungee Ball Ø 6 mm

ARTICLE	DIAMETER	LENGTH
BB-6-18-Z	6 mm	18 cm
BB-6-18-W	6 mm	18 cm
BB-6-25-Z	6 mm	25 cm



Maximum pull 200 kg.
Length includes hook.

Z=Black
G=Grey

SuperFix with swanneck Ø 8 mm

ARTICLE	DIAMETER	LENGTH
SFZ-FIX-8-18-Z	8 mm	18 cm
SFZ-FIX-8-18-G	8 mm	18 cm
SFZ-FIX-8-20-Z	8 mm	20 cm
SFZ-FIX-8-20-G	8 mm	20 cm
SFZ-FIX-8-23-Z	8 mm	23 cm
SFZ-FIX-8-23-G	8 mm	23 cm
SFZ-FIX-8-25-Z	8 mm	25 cm
SFZ-FIX-8-25-G	8 mm	25 cm

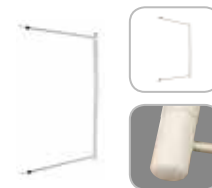

Tube diameter 33,7 mm
Tube thickness 2 mm.

Banner Stick

ARTICLE	COLOR	LENGTH
BS-90-W	White	90 cm

new

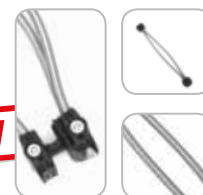

Maximum pull 135 kg.
Length includes hook.

Z=Black
A=Aluminium

StormFix double Ø 5 mm

ARTICLE	DIAMETER	LENGTH
SD-FIX-16-Z	5 mm	16 cm
SD-FIX-16-A	5 mm	16 cm
SD-FIX-18-Z	5 mm	18 cm
SD-FIX-18-A	5 mm	18 cm
SD-FIX-20-Z	5 mm	20 cm
SD-FIX-20-A	5 mm	20 cm
SD-FIX-22-Z	5 mm	22 cm
SD-FIX-22-A	5 mm	22 cm
SD-FIX-24-Z	5 mm	24 cm
SD-FIX-24-A	5 mm	24 cm



Maximum pull 200 kg.
Length includes hook.

G=Grey

TornadoFix Ø 6 mm

ARTICLE	DIAMETER	LENGTH
T-FIX-6-16-G	6 mm	16 cm
T-FIX-6-18-G	6 mm	18 cm
T-FIX-6-20-G	6 mm	20 cm
T-FIX-6-22-G	6 mm	22 cm
T-FIX-6-24-G	6 mm	24 cm



Maximum pull Ø 6 mm 80 kg,
Ø 8 mm 90 kg.
Length includes hook. *G=Grey*
Z=Black

StormFix Ø 6-8 mm

ARTICLE	DIAMETER	LENGTH
S-FIX-6-16-G	6 mm	16 cm
S-FIX-6-16-Z	6 mm	16 cm
S-FIX-6-18-G	6 mm	18 cm
S-FIX-6-18-Z	6 mm	18 cm
S-FIX-6-20-G	6 mm	20 cm
S-FIX-6-20-Z	6 mm	20 cm
S-FIX-6-22-G	6 mm	22 cm
S-FIX-6-22-Z	6 mm	22 cm
S-FIX-6-24-G	6 mm	24 cm
S-FIX-6-24-Z	6 mm	24 cm
S-FIX-8-16-G	8 mm	16 cm
S-FIX-8-16-Z	8 mm	16 cm
S-FIX-8-18-G	8 mm	18 cm
S-FIX-8-18-Z	8 mm	18 cm
S-FIX-8-20-G	8 mm	20 cm
S-FIX-8-20-Z	8 mm	20 cm
S-FIX-8-22-G	8 mm	22 cm
S-FIX-8-22-Z	8 mm	22 cm
S-FIX-8-24-G	8 mm	24 cm
S-FIX-8-24-Z	8 mm	24 cm

new



Maximum pull Ø 6 mm 50 kg,
Ø 8 mm 60 kg.
Length includes hook. *Z=Black*

Special Double Hook Ø 6-8 mm

ARTICLE	DIAMETER	LENGTH
SDH-6-20-Z	6 mm	20 cm
SDH-6-23-Z	6 mm	23 cm
SDH-6-25-Z	6 mm	25 cm
SDH-8-20-Z	8 mm	20 cm
SDH-8-23-Z	8 mm	23 cm
SDH-8-25-Z	8 mm	25 cm



Maximum pull 40 kg.
Hook is optional. *Z=Black*

Tir Rubber Ø 8 mm

ARTICLE	DIAMETER	LENGTH
TR-8-20-Z	8 mm	20 cm
TR-8-25-Z	8 mm	25 cm
TR-8-40-Z	8 mm	40 cm
TRSH	Hook	



Elastic band on roll diameter 6,
8 and 10 mm. Elastic is made of
natural rubber. *Z=Black*
W=White

new



Maximum pull 10 kg.
Length includes hook. *Z=Black*

Mini tensioner Ø 4 mm

ARTICLE	DIAMETER	LENGTH
SPAN-4M-12	4 mm	12 cm

Maximum pull 200 kg.
Length includes hook. *Z=Black*
G=Grey

SuperFix with S hook Ø 8 mm

ARTICLE	DIAMETER	LENGTH
SFS-FIX-8-18-Z	8 mm	18 cm
SFS-FIX-8-18-G	8 mm	18 cm
SFS-FIX-8-20-Z	8 mm	20 cm
SFS-FIX-8-20-G	8 mm	20 cm
SFS-FIX-8-23-Z	8 mm	23 cm
SFS-FIX-8-23-G	8 mm	23 cm
SFS-FIX-8-25-Z	8 mm	25 cm
SFS-FIX-8-25-G	8 mm	25 cm

Elastic roll Ø 6-8-10 mm

ARTICLE	DIAMETER	LENGTH
1170636-Z	6 mm	100 m
1170636-W	6 mm	100 m
1170738-Z	8 mm	100 m
1170738-W	8 mm	100 m
1170739-Z	10 mm	100 m
1170739-W	10 mm	100 m



Maximum pull 100 kg. *Z=Black*
Length includes hook.

Double banner Ø 6-8 mm

ARTICLE	DIAMETER	LENGTH
SPAN6-16H-Z	6 mm	16 cm
SPAN16H-Z	8 mm	16 cm
SPAN19H-Z	8 mm	19 cm



Snap-Off, sink and stainless steel casing with steel cutter. Blades 9 mm under a 30° angle, that specializes in graphic precision projects.

SNAP-OFF CUTTERS



MATERIAL : Steel	
ARTICLE	DESCRIPTION
CSX48-1	Stainless steel casing and cutter
CSX38-T-10	Spare blades
CSX9T-10	Spare blades

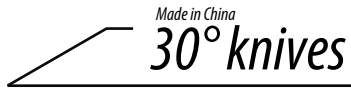

MATERIAL : Sink with stainless steel	
ARTICLE	DESCRIPTION
CSX48-N	Sink casing with stainless steel cutter
CSX38-T-10	Spare blades
CSX9T-10	Spare blades



Dispenser box with 60 knives. New positive and safety lock system. Quality steel blade. Fully retractable. 11 sharp snap-off edges 1 blade.

SNAP KNIVES ECO



MATERIAL : Plastic with steel blade	
ARTICLE	DESCRIPTION
MES	Box filled with 60 snap-off knives

Robust scissors to cut for years. Made of specially hardened stainless steel and ergonomic handles with comfortable rubber soft touch grip.

SCISSORS

MATERIAL: Stainless steel		
ARTICLE	LENGTH	COLOR
L254006	160 mm	GREEN
L254008	210 mm	GREEN
L254310	260 mm	BLUE



Banner tape for swapping jobs bizonyl. Line, making tunnel loops, remaining transparent. The solution for Bizonyl instead of stitching.

BANNER TAPE

BANNER TAPE		
ARTICLE	WIDTH	LENGTH
BT012	12 mm	25 m
BT015	15 mm	25 m
BT019	19 mm	25 m
BT025	25 mm	25 m
BT050	50 mm	25 m



Banner hem zoom replaces tape line. You tightens the edge with adhesive banner zoom tape for a perfect surface for grommets.

BANNER HEM TAPE

BANNER HEM TAPE		
ARTICLE	WIDTH	LENGTH
BT-VERST	40 mm	25 m



Lightweight cutting ruler with Anti-slip layer on the bottom. Raised edge to protect fingers. Different lengths available!

CUTTING RULER

MATERIAL: Aluminium

ARTICLE	LENGTH	DESCRIPTION
1735-050	500 mm	Cutting ruler
1735-060	600 mm	Cutting ruler
1735-100	1000 mm	Cutting ruler
1735-150	1500 mm	Cutting ruler
1735-200	2000 mm	Cutting ruler
1735-240	2400 mm	Cutting ruler
1735-300	3000 mm	Cutting ruler

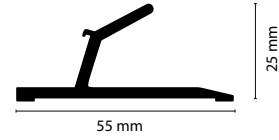

Make from every surface a cutting table with a soft cutting mat. Material: PVC. Thickness: 5 mm. Many sizes available.

SOFT CUTTING MAT



Available sizes:
Wid: 1000, 1200, 1500 and 1600 mm.
Length: from 700-10000 mm.

TAPE DISPENSER

ARTICLE	DESCRIPTION
DT0001	TAPE DISPENSER

Tape dispenser with brake, suitable for rolls of 50 mm x 66 m

TAPE DISPENSER



Brown and transparent packaging tape. Suitable to use with the tape dispenser DT0001.

PACKAGING TAPE



MATERIAL : Polyurethane film

ARTICLE	COLOR	WIDTH	LENGTH
VB5066	BROWN	50 mm	66 m
VT5066	TRANSPARENT	50 mm	66 m

Adhesive: Water-based acrylic
Carrier: polyurethane film
Maximum temperature: 60°C
Tensile strength: 150 N/25 mm
Adhesive strength: 6 N/25 mm
Thickness: 0,032 mm

LEDs are light emitting diodes. These are electronic components that convert electrical energy directly to light through the movement of electrons within the material of the diode. LEDs are important because due to their efficiency and low energy. They are beginning to replace most conventional light sources.

Duxoled universal LED modules: suitable for light boxes, channel letters, light lines and shop interiors. Duxoled LED modules are specifically designed for the sign and retail industry.



High-Power LED modules 2 LEDs, viewing angle 120°-140°

2 LEDs module

ARTICLE	DESCRIPTION	WATTS	VOLTAGE	NOMINAL	LIGHT INTENSITY	COLOR TEMPERATURE	LIGHT COLOR
DUX12-WW2	LED	0,48 W	12 V	40 mA	30 Lm	2500-3500 K	Warm White
DUX12-W2	LED	0,48 W	12 V	40 mA	30 Lm	5000-6500 K	White
DUX12-R2	LED	0,48 W	12 V	40 mA	10 Lm	621-624 nm	Red
DUX12-G2	LED	0,48 W	12 V	40 mA	20 Lm	521-524 nm	Green
DUX12-B2	LED	0,48 W	12 V	40 mA	6 Lm	464-467 nm	Blue
DUX12-Y2	LED	0,48 W	12 V	40 mA	7 Lm	586-589 nm	Yellow



High-Power LED modules 3 LEDs, viewing angle 120°-140°

2 LEDs module

ARTICLE	DESCRIPTION	WATTS	VOLTAGE	NOMINAL	LIGHT INTENSITY	COLOR TEMPERATURE	LIGHT COLOR
DUX12-WW3	LED	0,60 W	12 V	60 mA	30 Lm	2500-3500 K	Warm White
DUX12-W3	LED	0,60 W	12 V	60 mA	30 Lm	5000-6500 K	White
DUX12-R3	LED	0,60 W	12 V	60 mA	10 Lm	621-624 nm	Red
DUX12-G3	LED	0,60 W	12 V	60 mA	20 Lm	521-524 nm	Green
DUX12-B3	LED	0,60 W	12 V	60 mA	6 Lm	464-467 nm	Blue
DUX12-Y3	LED	0,60 W	12 V	60 mA	7 Lm	586-589 nm	Yellow



High-Power LED modules 2 LEDs mini, viewing angle 120°-140°

2 LEDs module

ARTICLE	DESCRIPTION	WATTS	VOLTAGE	NOMINAL	LIGHT INTENSITY	COLOR TEMPERATURE	LIGHT COLOR
DUX12-WW2-K	LED	0,48 W	12 V	40 mA	30 Lm	2500-3500 K	Warm White
DUX12-W2-K	LED	0,48 W	12 V	40 mA	30 Lm	5000-6500 K	White
DUX12-R2-K	LED	0,48 W	12 V	40 mA	10 Lm	621-624 nm	Red
DUX12-G2-K	LED	0,48 W	12 V	40 mA	20 Lm	521-524 nm	Green
DUX12-B2-K	LED	0,48 W	12 V	40 mA	6 Lm	464-467 nm	Blue
DUX12-Y2-K	LED	0,48 W	12 V	40 mA	7 Lm	586-589 nm	Yellow



High-Power LED modules 5 LEDs, viewing angle 120°-140°

5 LEDs module

ARTICLE	DESCRIPTION	WATTS	VOLTAGE	NOMINAL	LIGHT INTENSITY	COLOR TEMPERATURE	LIGHT COLOR
DUX12-WW5	LED	1,30 W	12 V	1083 mA	30 Lm	5000-6500 K	White



High-Power LED modules 3 LEDs RGB, viewing angle 120°-140°

3 LEDs module RGB

ARTICLE	DESCRIPTION	WATTS	VOLTAGE	NOMINAL	LIGHT COLOR	COLOR TEMPERATURE
DUX12-RGB3	LED	0,72 W	12 V	60 mA	Multi-Color	Multi-Color



RGB Controller

RGB Controller

ARTICLE	DESCRIPTION	AMP	VOLTAGE	DISTANCE
LED-0077	RGB-CONTROLLER	6 A	12/24 V	30 m



new



High-Power LED modules 3 LEDs, viewing angle 140° or 160°

2 LEDS module							
ARTICLE	DESCRIPTION	WATTS	VOLTAGE	NOMINAL	LIGHT INTENSITY	COLOR TEMPERATURE	LIGHT COLOR
DUX12-5W3-FB	LED	1,40 W	12 V	166 mA	45 Lm	6500-10000 K	<input type="checkbox"/> White



new



High-Power LED modules 3 LEDs, viewing angle 172°

2 LEDS module							
ARTICLE	DESCRIPTION	WATTS	VOLTAGE	NOMINAL	LIGHT INTENSITY	COLOR TEMPERATURE	LIGHT COLOR
DUX12-5W3-FC	LED	1,40 W	12 V	166 mA	45 Lm	6500-10000 K	<input type="checkbox"/> White



new



High-Power LED modules 1 LED, viewing angle 18°-50° and 25°-90°

2 LEDS module							
ARTICLE	DESCRIPTION	WATTS	VOLTAGE	NOMINAL	LIGHT INTENSITY	COLOR TEMPERATURE	LIGHT COLOR
DUX12-F1850	LED	1,50 W	12 V	125 mA	135 Lm	7900 K	<input type="checkbox"/> White
DUX12-F2590	LED	1,50 W	12 V	125 mA	135 Lm	7900 K	<input type="checkbox"/> White



LED Power supplies from Mean Well. These power modules have an entry range of 100-240vac and an exit voltage of 12VDC.



MEAN WELL DRIVERS



Economic performance



Low economic performance



Outdoor high performance



Outdoor performance



With our grommets press and stamps you can smoothly press grommets into a rapid pace.

GROMMET PRESSES



HANDPRESS TP-3 (Comfort)

HANDPRESS	
ARTICLE	DESCRIPTION
5399-9000-905	HANDPRESS



Press with mounted lever.



Air hose. This hose will only fit on the combination Mini compressor with pneumatic grommets press.

PNEUMATIC PRESS PR-10

PRESS PR-10	
ARTICLE	DESCRIPTION
5399-9000-800	PRESS PR-10
007-PC01010	COMPRESSOR
007-PCLUC	AIR HOSE



HANDPRESS PR-3 (with long lever)

HANDPRESS PR-3	
ARTICLE	DESCRIPTION
5399-9000-940	HANDPRESS PR-3

Grommets self-cutting brass nickel-plated. Dimensions are inside measurements. Our stamp sets are available in different variants.



GROMMETS AND STAMPSET



STAMPSETS						
ARTICLE	DESCRIPTION	DIAMETER	NR.	TP-3	PR-3	PR-10
5399-9008-904	STAMPSET	8,0 mm	#1	✓	✓	✓
5399-9009-904	STAMPSET	9,2 mm	#2	✓	✓	✓
5399-9011-904	STAMPSET	11,6 mm	#3	✓	✓	✓
5399-9015-904	STAMPSET	15,4 mm	#4	✓	✓	✓
5399-9018-904	STAMPSET	18,4 mm	#5	✓	✓	✓
5399-9040-904	STAMPSET	40,0 mm	#12	✗	✓	✗

GROMMETS

GROMMETS made of brass, color chrome			
ARTICLE	DESCRIPTION	DIAMETER	NR.
5310-0008-101	GROMMETS	8,0 mm	#1
5310-0009-101	GROMMETS	9,2 mm	#2
5310-0011-101	GROMMETS	11,6 mm	#3
5310-0015-101	GROMMETS	15,4 mm	#4
5310-0018-101	GROMMETS	18,4 mm	#5



GROMMETS made of brass, color chrome				
ARTICLE	DIAMETER	SHAPE	MATERIAL	COLOR
5310-0040-101	Ø 40 mm	OVAL	BRAS	CHROME
5310-0040-201	Ø 40 mm	OVAL	STAINLESS	MAT CHROME
5310-1500-140	Ø 40 mm	OVAL	NYLON	GREY

STAMPSET and SPACER					
ARTICLE	DIAMETER	SHAPE	TP-3	PR-3	PR-10
5310-0040-101	Ø 40 mm	OVAL	✓	✓	✗
5310-0040-201	Ø 40 mm	OVAL	✓	✓	✗
5310-1500-140	SPACER		✗	✗	✗

Suction Cup with siphon
 Ø 100 mm, available in the
 colours white and black.

SUCTION CUP WITH SIPHON



SUCTION CUP WITH SIPHON

ARTICLE	DESCRIPTION
ZUIGHH	WHITE SUCTION CUP
ZUIGHZ	BLACK SUCTION CUP

Suction cup Ø 100 mm and
 Ø 20 mm with lever flags
 holder.

SUCTION CUP STAINLESS STEEL

SUCTION CUP STAINLESS STEEL

ARTICLE	DESCRIPTION
ZUIGWIN	SUCTION CUP STAINLESS STEEL



Suction cups are ideal for
 putting up a display or
 advertising applications.
 Suction cups are available
 in many varieties such as a
 suction cup with hook, wire
 end, button and a double
 suction cup. The product
 is applicable for multiple
 purposes.

SUCTION CUPS

CUP WITH WIRE END

SUCTION CUP WITH WIRE END

ARTICLE	DESCRIPTION	DIAMETER WIRE END
ZUIGM	CUP WITH WIRE END	Ø 40 mm
ZUIGM50	CUP WITH WIRE END	Ø 50 mm



CUP WITH HOOK

SUCTION CUP WITH HOOK

ARTICLE	DESCRIPTION
ZUIGH	CUP WITH HOOK

CUP WITH HEAD

SUCTION CUP WITH HEAD

ARTICLE	DESCRIPTION
ZUIGK	CUP WITH HEAD



CUP WITH SQUEEZE CLAMP

SUCTION CUP WITH SQUEEZE CLAMP

ARTICLE	DESCRIPTION
ZUIGKNJP	CUP WITH SQUEEZE CLAMP



DOUBLE CUP

DOUBLE SUCTION CUP

ARTICLE	DESCRIPTION
ZUIGD	DOUBLE SUCTION CUP



These nuts (in nylon) have a
 self-lubricating effect.
 By the material properties
 they protect against moisture.

NYLON NUTS



NYLON NUTS

ARTICLE	DESCRIPTION	COLOR
ZUIGMMT	NYLON NUT	TRANSPARENT
ZUIGMMZ	NYLON NUT	BLACK
ZUIGMMW	NYLON NUT	WHITE

Spacers for letters are unique plastic spacers for confirming letters to the wall or façade. They are UV resistant and of high quality.

SPACERS FOR LETTERS



SPACERS	
ARTICLE	DESCRIPTION
UYUP449100	SPACER 20 mm
UYUP44900	SPACER 25 mm

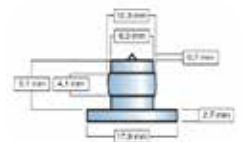
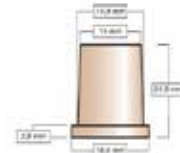
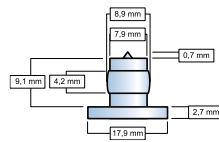
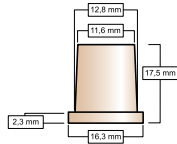
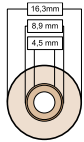

Spacers you can glue on DiBond with ISR Kit 70-01. Surface cleaning with Prep M. Drying time approx. 36 hours.

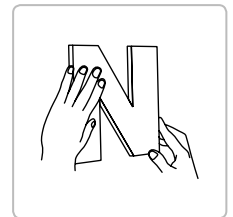
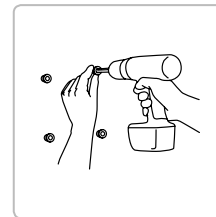
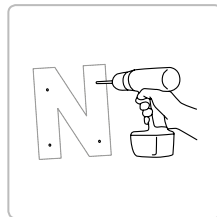
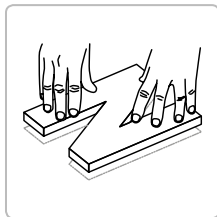
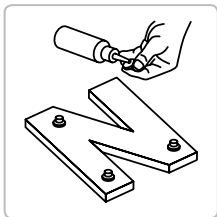

Flag, Bizonyl with adhesive or screw bare flag holder. Pole length: 700 mm.

COMBI FLAG



COMBI FLAG	
ARTICLE	DESCRIPTION
VLAGWIN	Flag with pole, 480 x 400 x 400 mm
VLAGH19	Flagpole holder with adhesive pvc

Window banner made entirely of plastic, suction cup with pole. Bracket length: 370 mm. Total length: 510 mm. By its sophisticated design, the window banner has an extra support to ensure that it hangs stable at the window. Supplied without banner/flag.

WINDOW BANNER



WINDOW BANNER	
ARTICLE	DESCRIPTION
BPF145	WINDOW BANNER

COMBI FLAG	
ARTICLE	DESCRIPTION
WINDOWSIGN	Complete
VLAGWIN	Flag with stick, 480 x 400 x 400 mm
ZUIGWIN	Suction cup



Unique advertising article for a smooth surface, such as glass, Trespac etc. Ideal for shop offers, decoration of malls etc. Suction Cup diameter: 100 mm. Completely galvanized. Pole length: 700 mm, including button, all PVC. Material: bizonyl flag. Advertising size: height 380-460 mm, width 400 mm.

WINDOW SIGN FLAG + HOLDER

CALL FOR PRICE INFORMATION

**HOLLAND[®]
SNAP FRAME**
Sign & more



Aluminium profiles
High Power LEDs and drivers
Illuminated products
Tubes, clamps and tensioners
Snap frames
Poster Systems
Roll banners and quick banners
Pavement signs
Exhibition systems
Presentation systems
Showboards and noticeboards
iPad stands
Brochure systems
Tape and mounting
Cutting materials
Other products
Profiles and parts
Chalk- and whiteboards
Signage
Leaflet dispensers
Menuboards
Textile frames

Holland Snap Frame BV
De Wel 12a
3871 MV Hoevelaken
The Netherlands

www.hollandsnapframe.com
info@hollandsnapframe.com
tel.: +31 33 25 81 179

